

**Niblack Wastewater
Treatment and Disposal Application
under the
Waste Management Permit**

April, 2007

**Submitted to
Alaska Department of Environmental Conservation
Division of Water (Wastewater Discharge Program)
and Alaska Department of Natural Resources
(Large Mine Permitting Team)**

**Submitted by:
Niblack Mining Corporation
Owner/Operator**

**Contact Person:
Darwin Green, Vice President, Niblack Mining Corporation
615-800 West Pender Street
Vancouver, BC, Canada V6C 2V6
(604) 484-5045**

**Prepared by:
RTR Resource Management, Inc.
1109 Main St; Suite 480
Boise, Idaho 83702
Contact Person: Rick Richins
(208) 343-8727**

TABLE OF CONTENTS

SECTION 1. INTRODUCTION.....	1
1.1 BACKGROUND	1
1.2 TEMPORARY PERMIT REQUIRED.....	2
1.3 LOCAL CLIMATE	2
1.4 TOPOGRAPHY	3
1.5 SEISMICITY.....	3
1.6 ACCESS	4
1.7 WATER RESOURCES	4
1.8 SITING CONSIDERATIONS FOR LAND APPLICATION/ATTENUATION SITE.....	7
1.9 SEPARATE PERMIT FOR INDUSTRIAL SOLID WASTE MANAGEMENT	7
SECTION 2. OVERVIEW OF WATER MANAGEMENT/TREATMENT SCHEME.....	9
2.1 WATER MANAGEMENT SCHEME OVERVIEW	9
2.2 WATER TREATMENT AND BMP APPROACH	11
2.2.1 <i>Wastewater Minimization</i>	11
2.2.2 <i>Water Management Needs</i>	11
2.2.3 <i>Contingency Water/Explosives Management Practices</i>	14
2.2.4 <i>Employee Education and Training</i>	14
2.2.5 <i>Inspections and Monitoring</i>	15
SECTION 3. ESTIMATED FLOWS AND FACILITY DESIGNS	17
3.1 DISCHARGE ESTIMATES	17
3.2 WATER MANAGEMENT DESIGN FOR ACCESS DRIFT	18
3.3 WATER MANAGEMENT DESIGN FOR TEMPORARY PAG/ML STORAGE SITE	18
3.4 WATER MANAGEMENT DESIGN FOR THE NAG STORAGE SITE	19
3.5 WATER TREATMENT FACILITY DESIGN.....	20
3.6 LAND APPLICATION/DISPERSION SYSTEM DESIGN.....	23
SECTION 4. REGULATORY REQUIREMENTS AND OPERATING PROCEDURES 26	26
4.1 REGULATORY REQUIREMENTS	26
4.2 STANDARD OPERATING PROCEDURES	26
SECTION 5. REFERENCES.....	29

LIST OF TABLES

Table 1	Mean Monthly and Annual Precipitation Data
Table 2	Offsite Drainage Basin Characteristics
Table 3	Key Components of Underground Water Management
Table 4	Explosives/Water Management BMPs for Project Construction
Table 5	Representative Water Treatment Screening Matrix
Table 6	Treatability Simulations

LIST OF FIGURES

Figure 1	Location Map
Figure 2	Claims Map
Figure 3	Baseline Water Quality Stations
Figure 4	Major Drainage Basins
Figure 5	General Site Plan
Figure 6	Property Section
Figure 7	Site Plan Details
Figure 8	Wastewater Collection and Treatment Concepts
Figure 9	Pre-Development Conditions at PAG Waste Rock Pile
Figure 10	PAG Waste Rock Pile Design Detail and Water Routing
Figure 11	PAG Liner Details
Figure 12	PAG Waste Rock Pile Construction Sequence and Water Routing Schematic
Figure 13	NAG Waste Rock Dump Section Details
Figure 14	Settlement/Treatment Pond Section

LIST OF APPENDICES

Appendix A	Calculations for Stormwater Drainage Structures and Culverts
Appendix B	Calculations for Land Application
Appendix C	Land Application Reporting Form

Section 1. Introduction

1.1 Background

Niblack Mining Corporation (NMC) is proposing to construct an underground exploration project at the Niblack property located on southern Prince of Wales Island about 30 miles southwest of Ketchikan in southeast Alaska. The area has been explored for minerals since at least 1899. The property is in the Ketchikan Recording District on Craig A 1 USGS Map Quadrangle geologic map sheet. Figure 1 shows the location. The construction is located at the head of Niblack Anchorage, on the north slope of Lookout Mountain. The Lookout Geological Unit contains mineralization, which is the target of this exploration project.

The underground exploration project includes construction of a new portal and approximately 6000 feet of access drift. The purpose of the underground development is the establishment of drill stations to delineate additional zones of mineralization. A short length of the main access drift (40 ft or less) will pass through a mineralized zone from which a 500 ton test sample may be collected and shipped offsite for metallurgical testing. An estimated 23% of the waste rock encountered during construction is considered potentially acid generating and potentially metals leaching (PAG/ML), and will require special storage and water management considerations. The remaining 77% of the waste rock is largely acid consuming with negligible potential to generate acid or leach metals, and is referred to as non-acid generating (NAG) waste rock. Methods for monitoring and managing NAG vs. PAG/ML rock as part of the overall construction process are described in a separate permit application, and the *Niblack Operational Characterization Plan*, Knight Piesold Consulting, 2007.

PAG/ML waste rock will be temporarily stored at a lined facility until project closure, after which it will be returned underground. NAG waste rock will be placed at a separate, permanent storage site. The construction activities are described in more detail later in this document as well as in the *Niblack Project Underground Exploration Plan of Operations*, Niblack Mining Corporation, 2007. The underground exploration project will require up to 24 months to complete.

The property is comprised of 17 patented mining claims, 101 staked federal claims, and two Alaska State Tideland claims (Figure 2). All claims are owned 100% by NMC with a Net Smelter Return (NSR) to Barrick, and a Net Profits Interest (NPI) to Cook Inlet Resources, Inc. Native Corporation. The claims are to the north of Niblack Anchorage in Moira Sound. All proposed development will be located on privately held patented mining claims which include ownership of surface rights.

Early mining history involved a copper discovery and development by the G.M. Wakefield Mineral Land Company in 1902. Early records show the mine shipped over 30,000 tons of copper/gold/silver ore between 1905 and 1908. More recently, Cominco American (1974-1976), Anaconda (1977), Noranda (1892), and Lac (1984-1993) performed exploration at the site. Abacus Minerals Corporation became involved in 1995, and NMC most recently in 2005.

1.2 Temporary Permit Required

With this application, NMC is applying for a Wastewater Treatment and Disposal authorization by the Alaska Department of Environmental Conservation (ADEC) under a Waste Management Permit for the site. The application is for a wastewater system designed to treat potential leachate from a temporary PAG/ML waste rock storage site as well as underground water from the construction of an access drift. The wastewater system is designed to control the 24-hour, 25-year storm event and to discharge water from a water storage/treatment pond through a drip emitter system to a natural attenuation system. Calculations for storm water drainage structures and culverts are shown in Appendix A. The wastewater permit application would be authorized under 18 AAC 72.500 and 18 AAC 72.600. Concurrent with this application, NMC is applying for an Industrial Solid Waste authorization under the Waste Management Permit for the site.

This application is consistent with the Notice of Intent (NOI) and Storm Water Pollution Prevention Plan (SWPPP), which were submitted previously under separate cover (October 24, 2006). The SWPPP is included as an appendix to the *Niblack Underground Exploration Plan of Operations, NMC, 2007*. The proposed project involves construction, mineral exploration, water management and monitoring.

The proposed wastewater treatment facility and land application/attenuation polishing area would be located totally on private land. There would be no discharge to waters of the U.S. The purpose of the permit application is:

1. To provide for interim treatment of construction and dewatering wastewater associated with the drift to provide drill access to the Lookout mineralized zone at depth.
2. To protect local surface and ground water resources.

1.3 Local Climate

Climatic conditions are typical of the Alaska Panhandle region with warm summers and relatively wet, cool winters. Average monthly temperatures range from 35°F during the month of January to 58°F in July (Table 1). Total evaporation is limited. Snow cover can be heavy at higher elevations. Rainfall is often very heavy with average annual precipitation of about 174 inches, as measured in nearby Ketchikan. The area encompassed by the claims is covered by temperate rainforest at lower elevations, giving way to sparse sub-alpine vegetation at the highest elevations.

TABLE 1.

**Niblack Project
MEAN MONTHLY AND ANNUAL METEOROLOGY DATA
KETCHIKAN, ALASKA**

	Jan	Feb	Mar	Apr	May	Jun	Jul	Aug	Sep	Oct	Nov	Dec	Annual
Precipitation	11.94	11.33	11.15	9.85	8.7	6.95	6.43	9.14	12.18	20.29	15.73	13.71	137.4
Snowfall	13.3	9.5	4.1	0	0	0	0	0	0	0	2.1	7.9	36.9
Temperature	33.6	36.3	38.3	43	48.5	53.8	57.7	58.3	53.1	45.8	38.8	35.5	45.2

Notes: 1 – Data is from the Alaska Climate Research Center web page at <http://climate.gi.alaska.edu/Climate/Temperature/index.html>
2 – Mean values are for data from 1971 to 2000.

1.4 Topography

The property terrain is mountainous; moderate to very steep slopes rise from Niblack Anchorage. Total relief is almost 2300 feet; elevations range from sea level to the highest point west of the head of Niblack Anchorage.

1.5 Seismicity

Alaska is the most seismically active state in the U.S. and in 1964 experienced the second largest earthquake ever recorded worldwide. Both crustal earthquakes in the continental North American Plate and subduction earthquakes affect the Alaska region. Historically, the level of seismic activity is highest along the south coast, where earthquakes are generated by the Pacific tectonic Plate subducting under the North American plate. This seismic source region, known as the Alaska-Aleutian megathrust, has been responsible for several of the largest earthquakes recorded, including the 1964 Prince William Sound magnitude 9.2 earthquake. Although there is potential for a future large subduction earthquake (M 9+) along the southern coast of Alaska, it is likely that it would be located far from the project site (over 500 miles).

The seismotectonic setting of southeastern Alaska is influenced directly by the interaction between the Pacific and North American plates. Stresses in the crust derived from movement of the plates are accommodated by a series of faults and fault systems. Several major active faults in southern Alaska have generated large crustal earthquakes within the last century. The most likely sources for an earthquake significant to the project site are the Fairweather-Queen Charlotte fault and the Chatham Strait Fault. These faults are both located approximately 90 miles west of the project site. There are no active faults in the project area. The Fairweather-Queen Charlotte fault system is capable of generating large earthquakes of approximately magnitude 8.0-8.3. There is potential for earthquakes of up to approximately magnitude 7.0

occurring along the Chatham Strait Fault. These fault systems present the greatest earthquake hazard to southeast Alaska. A map of active earthquakes in Alaska is available at http://www.aeic.alaska.edu/html_docs/pdf_files/earthquakes_in_Alaska.pg.pdf - Earthquakes in Alaska: Haeussler, P.J and Plafker, 2004, US Geological Survey publication.

Seismic conditions were considered in designing the various project facilities, including waste rock storage sites and the water treatment facility for the project. These analyses are described in a separate report: *Geotechnical Summary of the Niblack Project Waste Dumps, Knight Piesold Consulting, 2006*. Specific design and construction requirements for the two waste storage sites include: foundation stripping, construction in lifts from the bottom up, for the PAG/ML site construction on a bedrock foundation with a geosynthetic liner, and installation of a safety catchment berm for the NAG site.

1.6 Access

Access to the camp at Niblack Anchorage is by boat, helicopter, or float equipped aircraft. On-property travel is most efficiently done by 4-wheel ATV, pickup, and helicopter. A 16 ft. wide running surface road was constructed in 2006. The total estimated length of the road is about 5,000 ft.

1.7 Water Resources

The project is located along the bottom and lower slopes of a small, steep-sided watershed that drains directly into Niblack Anchorage. Two perennial streams referred to as Camp Creek and Waterfall Creek (southern-most) flow directly through the project, and are immediately south of the historic mine camp. Many small intermittent drainages, swales, and rivulets flow through the area and eventually feed into these streams, or directly into Niblack Anchorage.

Ground water in the project area is present in two domains: 1) low residence time near surface colluvial ground water at 10-30 ft. and 2) deeper longer residence time ground water at approximately 30 ft. Data from road cuts, ground water wells, existing exploration drill holes, and soil borings from wetland delineation work appear to indicate or suggest channelized or conduit-like, highly variable flow in colluvial ground water, which is directly related to precipitation.

Water quality in the project area is generally good, although seasonally characterized by some naturally elevated metals concentrations, which occur as background conditions. These conditions, which periodically exceed ADEC Water Quality Standards (Fresh Water Aquatic Life), are described in the environmental baseline report: *Niblack Water Quality Baseline and Site Monitoring Plan, Knight Piesold Consulting, 2007*.

Surface water quality monitoring has been occurring within the Niblack Project study area since 1996 in order to establish baseline water quality for the area. Samples were collected in October 1996, September 1997, April 2005 and February, May, August, October and December of 2006 and sampling will continue through 2007 and during advanced exploration activities. The location of the established baseline water quality sites are shown on Figure 3 and detailed in

Niblack Water Quality Baseline and Site Monitoring Plan, Knight Piesold Consulting, 2007. Ground water monitoring commenced late in 2006. Both surface and ground water monitoring will continue in advance of construction activities to further establish natural background conditions.

Proposed site wide compliance points for this permit application involve downstream surface water monitoring and wetland groundwater sites as shown and described in the *Niblack Water Quality Baseline and Site Monitoring Plan, Knight Piesold Consulting, 2007.* Monitoring schedule, parameters, protocol and reporting requirements are also described in the document. Sitewide sampling will occur downgradient of facilities, including land application/dispersion areas and waste rock storage sites. These sites represent the points or locations, where the highest concentrations of hazardous constituents migrating off the permit boundary could potentially be detected.

The current layout for surface water compliance points includes eight samples sites that account for upgradient and downgradient water quality within three of the creeks and streams within the immediate project area. From south to north the names of these creek systems are Waterfall Creek, Camp Creek and Unnamed Creek 1 (adjacent to old camp facilities). A ninth site is located on Unnamed Creek 2, downgradient of the NAG waste rock storage site, and a tenth site is located at the base of the PAG/ML waste rock storage site as part of a leak detection system. No upgradient site is located on Unnamed Creek 2 because of the short length of the stream system. Some sites may be relocated and additional sites selected when needed, and as approved by ADEC, as the project proceeds into construction, operation and closure.

Five permanent monitoring wells were installed in February, 2007 with guidance in establishing locations from ADEC. These are shallow wells located down-gradient from surface facilities. Two deeper wells (GW Site 1 and GW Site 2) installed in late 2006 are located north and south of Camp Creek. These are located at a depth of 28-30 ft. below ground surface. Location and description of groundwater wells are detailed in *The Niblack Water Quality Baseline and Site Monitoring Plan, Knight Piesold Consulting, 2007.* Some sites may be relocated and additional sites selected when needed, and as approved by ADEC, as the project proceeds into construction, operation and closure.

Both hydric and non-hydric soil conditions exist in the area. These were shown in soil pits excavated for a wetlands evaluation. Non-hydric soils had a shallow to moderately deep (3-7 inches) organic horizon overlying mineral soils. Specific soils characteristics are presented in the document: *Niblack Property Preliminary Jurisdictional Wetlands Delineation, HDR, 2006.* Selected sections and figures are shown. This evaluation was used in determining land application sites.

Hydrology was also evaluated at the site. Staff gauges were previously installed at the site, and in 2006 an automatic datalogger was installed to improve data retrieval. A peak rainfall of about 20 inches/month occurs in October (see previous Table 1). Engineering calculations for stormwater drainage structures and culverts prepared by Knight Piesold Consulting are described later in this document

The project area was divided into drainage basins for planning purposes (Figure 4). The lower boundary of basins B and G is the upper end of the PAG/ML and NAG waste disposal areas, respectively. These two waste storage sites, the PAG/ML being temporary and the NAG storage site permanent, are the focus of NMC's wastewater and stormwater management strategy. Runoff from these basins will be intercepted by diversion ditches upslope from the PAG/ML and NAG areas and conveyed to adjacent drainage channels. This management schedule is described in more detail and shown later in the application. A summary of hydrologic features is presented below in Table 2, with calculations presented in Appendix A.

TABLE 2
Offsite Drainage Basins Characteristics

Basin	Description	Basin Area (acres)	Peak Runoff from 5-in Precipitation Event (cfs)	Preliminary Estimate for Culvert or Diversion Ditch
A	Unnamed drainage north of PAG/ML Disposal Area	21.13	12.1	24-inch diameter culvert
B	PAG/ML Disposal Area	1.18	0.9	Trapezoidal channel, 2-ft bottom width, 2:1 side slopes, 0.5 ft deep
C	Camp Creek	359	206.2	2 x 48-inch diameter culverts
D	North Waterfall Creek	65.13	37.4	36-inch culvert
E	South Waterfall Creek	43.59	25.03	36-inch culvert
F	Unnamed drainage east of portal area	45.91	26.37	36-inch culvert
G	NAG Disposal Area	24.58	18.48	Trapezoidal channel, 3-ft bottom width, 2:1 side slopes, 1-ft deep

Peak flows were calculated using the Technical Release 55 (TR-55) hydrology model (U.S. Department of Agriculture, 1986), which uses basin area, the 24-hour rainfall for the selected return interval, the runoff curve number (CN) and the time of concentration to estimate the instantaneous peak flow and runoff hydrograph for a single drainage basin or a network of basins.

Basin areas were measured using the site map. According to Miller, 1963, the 24-hour precipitation at the site varies from 5 inches for the 2-year return period, to 6 inches for the 25-year return period. A precipitation value of 5 inches was used to calculate the peak flows for the seven offsite basins, since the expected duration of this project is less than 18 months.

A runoff curve number of 60 was used for all offsite basins. This curve number is typical for soils in heavily forested areas with a relatively high infiltration rate, and is representative of the soils at the Niblack site. The time of concentration for each basin was calculated using the methods described in the TR-55 manual. The times of concentration for these basins are relatively short due to the steep slopes of the basins.

Other sources of water flow considered in the design of water management and treatment facilities include ground water from construction excavation dewatering of underground drifts and leachate collected from the collection system beneath the temporary PAG/ML waste rock storage facility. Estimated flows for the purposes of defining wastewater treatment needs are described later in this application.

1.8 Siting Considerations for Land Application/Attenuation Site

Topography and suitability considerations were addressed in siting land application areas for the Niblack property. Temperature and precipitation information were important site evaluation considerations. Land use in terms of proximity to water courses, wells and other construction activities were evaluated. Other siting criteria for facilities siting included:

- location of site with respect to point of wastewater collection and conveyance
- compatibility with other potential uses at the site (facilities siting)
- land ownership (private land was assigned highest priority)
- proximity to wetlands and fish-bearing surface waters (wetlands were avoided in facilities siting and buffers were established around creeks)
- soil and vegetation types
- geology and potential connection with local ground water
- number and size of available land parcels for land application (rest/rotation)

The designs discussed later in this document are “conservative”, with respect to the criteria listed above. They are conservative in that they were selected so as not to cause impacts to surface or ground waters, given a variety of demanding site characteristics. These include late winter/early spring thaws or precipitation events with high runoff, and the potential for hydraulic overload at the sites.

The land application/attenuation facility was sited so as not to contribute to any nuisance conditions or to adversely affect public health. Land application will be conducted utilizing best practical methods, BMPs, and best available pre-treatment and treatment processes.

1.9 Separate Permit for Industrial Solid Waste Management

A separate Industrial Solid Waste Permit application was submitted to ADEC and the Large Mine Permit Team (LMPT) to address the regulation of above ground temporary PAG/ML waste rock storage at the project site. Figure 5 shows the proposed general site plan. Figure 6 shows a cross-section of the project. While most of the waste rock produced by the construction of the

exploration drift will be non-acid generating and non-metals leaching (about 77% or an estimated 46,600 cubic yards), approximately 14,300 cubic yards are potentially acid-generating and/or potentially metals leaching and will require special handling and management (Figure 7). The testing program during construction, as well as the design for the facility and monitoring program are described in the solid waste permit application, in the *Niblack Operational Characterization Plan, Knight Piesold Consulting, 2007*, and in the *Niblack Water Quality Baseline and Site Monitoring Plan, Knight Piesold Consulting, 2007*. No special management controls are therefore described herein. This PAG/ML rock will be stored in a manner that temporarily, and permanently, prevents the potential for surface and ground water impacts (as detailed in Section 3.3).

Section 2. Overview of Water Management/Treatment Scheme

2.1 Water Management Scheme Overview

The proposed excavation wastewater “fluid management area” which includes the underground drift construction, will involve a three-step wastewater treatment process to include: 1) minimization and pre-treatment underground, plus 2) settling in a “frac tank” and treatment in the water treatment facility (additional settling, chemical coagulation/precipitation treatment if necessary), plus 3) dispersion and land infiltration for final ‘polishing’. The treatment will also be provided to wastewater discharged from the PAG/ML facility. A section view of the access drift construction and exploration project is shown in Figure 6. The overall waste management/treatment approach is summarized in Figure 8.

Run-on storm water will be diverted around both the NAG and PAG/ML storage sites, back into existing channels or dispersed to undisturbed forest floor. Run-off from the NAG storage site will be collected in sediment ponds and traps below the site.

The overall water management area is defined as that area within which NMC would actively employ source controls like minimization, water management, and explosives’ BMPs. Water dispersion, BMPs and water treatment would also be used in order to limit potential surface and ground water quality impacts related to the underground construction activities. Section 2.2 of this application discusses BMPs in more detail.

Water management will also involve establishing down-gradient surface and ground water “compliance points”. A water quality monitoring program will be installed to insure that the BMPs and water treatment facilities are working efficiently. The “efficiency” of the water management program would be measured at these compliance points for surface and ground water. These locations are discussed and shown in the *Niblack Water Quality Baseline and Site Monitoring Plan, Knight Piesold, 2007*.

The water management control area will focus on underground water collection and BMPs, followed by surface treatment of collected waters. The underground BMPs would target TSS and nitrates. Surface BMP’s at the PAG/ML site will focus on minimization of waters coming in contact with PAG/ML waste rock, reducing the potential for ARD, metals leaching and TSS. Secondary treatment will be by combined settling and chemical precipitation (if necessary) at a two-stage water treatment facility. This treatment will reduce TSS, and metals, and maintain proper pH levels. Final treatment by polishing via land application will be the third level of water management. This will involve rotating drip emitter and/or spray systems, snow-making, and treated water reuse in the underground drilling program. The schematic that follows shows the construction wastewater treatment flowsheet and water treatment scheme for the Project.

Schematic Niblack Construction Wastewater Treatment

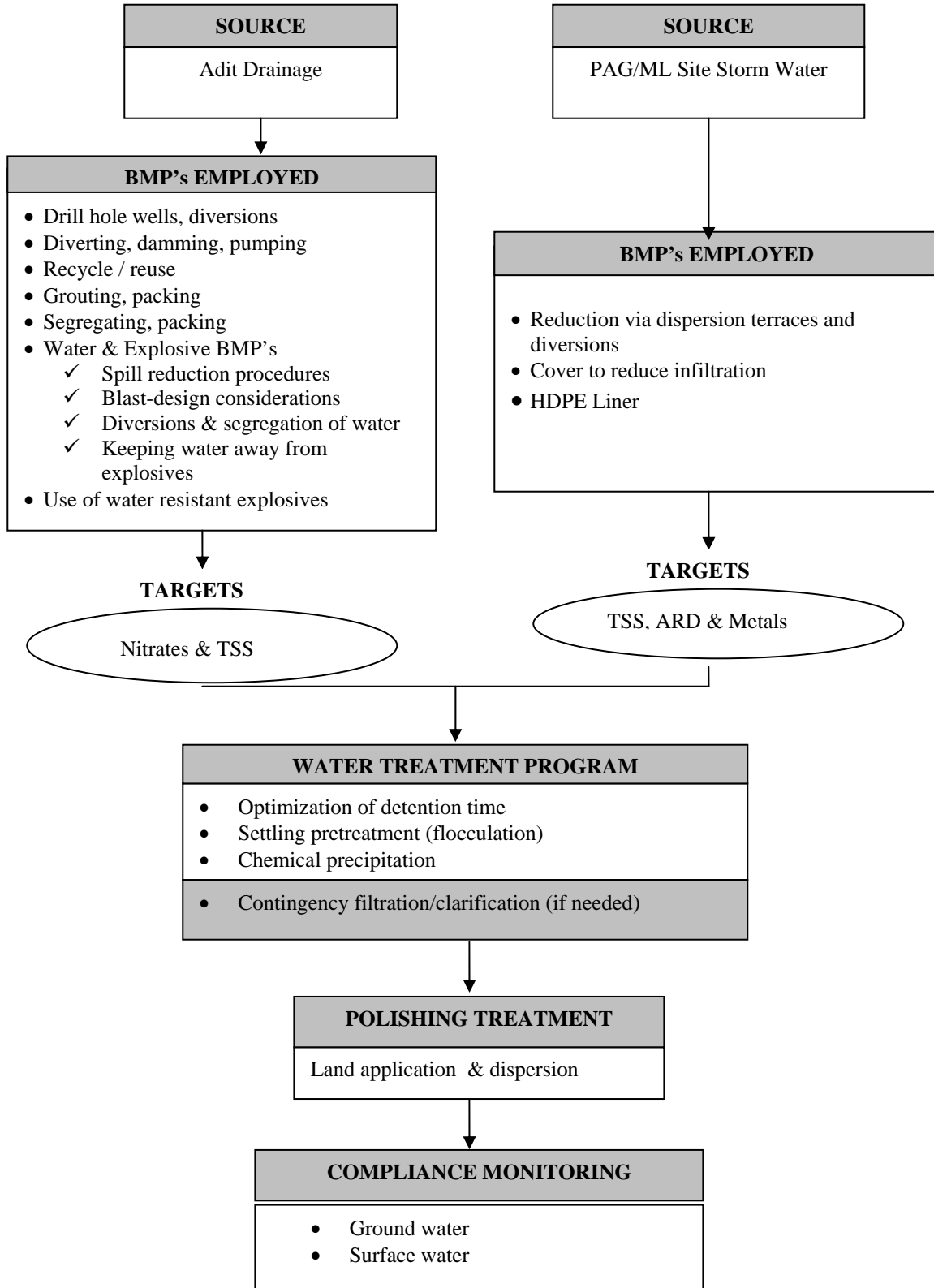

2.2 Water Treatment and BMP Approach

A permit is required from ADEC under 18 AAC 72.500 and 18 AAC 72.600 for the discharge of non-domestic wastewater to land or waters of the state, including ground water. Since the proposed discharge from the water treatment facility (WTF) will not be to wetlands or other waters of the U.S., an NPDES permit (EPA) is not required under 33 U.S.C. § 1342 Section 402 of the Clean Water Act.

NMC proposes to use a combination of water treatment processes and BMPs to meet State of Alaska water quality criteria. NMC does not intend to discharge construction dewatering fluids to areas adjacent to contaminated sites or drinking water wells, or to waters of the U.S. No domestic wells are located within one mile radius of the land application/dispersion site.

2.2.1 *Wastewater Minimization*

Minimization and pretreatment of excavation water underground will be an important feature of the NMC water management plan. This will include: water explosives management by BMPs during construction methods to limit excavation water inflow like grouting and packing, treatment in underground sumps using flocculants, and other water management controls involving polymer coating (i.e. Mineguard or Rockguard™) over rock fissures and surfaces to stabilize and/or retard ground water inflow/infiltration into the excavation area, and the temporary PAG/ML storage site.

2.2.2 *Water Management Needs*

A general approach to water management during the underground construction is highlighted below in Table 3.

TABLE 3.
Key Components of Underground Water Management

Water Management Approach	Planned BMPS
<ul style="list-style-type: none"> • Sample water from active work areas 	<ul style="list-style-type: none"> • Keep high nitrogen waters separate • Treat separately or pipe for reuse • Mix with low nitrogen waters • Monitor water quality as listed in the <i>Niblack Water Quality Baseline and Site Monitoring Plan, Knight Piesold Consulting, 2007</i>
<ul style="list-style-type: none"> • Consider all sources (overall) 	<ul style="list-style-type: none"> • Determine mixed water quality • Evaluate options for treatment, dilution, or nitrogen elimination
<ul style="list-style-type: none"> • Consider water and construction management 	<ul style="list-style-type: none"> • Separate and divert water for reuse or other options (drilling, road watering, other) • Coordinate water and explosives management; water and explosives management options may not be easily separated

In accordance with this flowsheet, Table 4 below describes prescriptive underground BMPs and procedures that will also be utilized by NMC for controlling or reducing explosives losses, and related leaching of ammonia and nitrates into surface or ground waters during construction activities at Niblack.

Water gel or emulsion explosives are generally preferred. ANFO may also be used due to its very good safety record and high detonation velocity. Emulsion type explosives will always be used in wet conditions where water management is not effective, based on water quality monitoring. These have a lower leaching rate, because ammonium nitrate is contained in an aqueous phase surrounded by oil and wax.

**TABLE 4.
Explosives/Water Management BMPs for Project Construction**

Potential Storage, Transfer and Loading Losses	Planned BMPs to Mitigate Impacts
1. General spillage of explosives during storage and loading. Ammonium nitrate mixed w/fuel oil makes ANFO. ANFO can be loaded in large diameter holes, pneumatic deliver, and sealed bag form.	<ul style="list-style-type: none"> • Train employees in explosives handling. • Provide properly maintained storage and loading equipment, and ensure employees are trained. • Encourage good-housekeeping and providing cleanup equipment and supplies to remove and dispose of spilled explosives.
2. Bulk explosives may spill out of poorly designed or damaged bins and transfer augers. Spills from bulk emulsion type explosives (if used) can occur at storage tank outlets and at pump-transfer areas.	<ul style="list-style-type: none"> • Locate bulk-explosive bins or storage tanks in dry areas allowing easy clean-up and no dissolution. Storage areas and loading equipment will be inspected and maintained regularly to prevent explosive spills and to facilitate clean-up.
3. Improper handling and loading practices can cause a significant amount of explosive spillage.	<ul style="list-style-type: none"> • Provide training to upgrade loading procedures and associated spillage of explosives during transfer and loading into blastholes.
4. If an entire bag of explosives is not used at the end of a loading procedure, spillage can occur	<ul style="list-style-type: none"> • Ensure that the bags are properly sealed and returned to storage to reduce spillage of any remaining explosives.
5. During loading, explosives are sometimes ejected from the hole as blowback. Blasting shock and pressure can blow away the collar of adjacent firing holes. Explosives within these collar regions are cut off and end up undetonated in the shot rock.	<ul style="list-style-type: none"> • Prevent overloading of drill holes by establishing minimum open collar lengths.
6. Loading explosives into wet or damp holes can dissolve and desensitize explosives and cause partial or total failure to detonate.	<ul style="list-style-type: none"> • See water management BMPs later in this discussion. • Prior to explosives loading, blowing out water in drill holes with compressed air. Use water resistant explosives.

The explosives BMP program will also attempt to limit incomplete detonations and misfires by using blast designs that consider the following measures:

- Multiple in-hole delay primers may be used in areas where ground movement could occur.
- Delay times will be adjusted to reduce “cutoffs”.
- When using water gel or emulsion explosives, drill hole spacings will be modified and/or relief holes will be used, as appropriate.

2.2.3 *Contingency Water/Explosives Management Practices*

Contingency water management practices will be initiated if high ammonia or nitrate levels and excessive water are observed at the Niblack project. The following contingency water management measures will be considered:

- Use of hole liners in wet areas of the drift to isolate explosives from water.
- Drilling into water producing zones before blasting in order to facilitate drainage of the zones (drill-hole wells may be used in some cases).
- Diverting, damming, channeling, and/or pumping all free-flowing water away from active blast areas to reduce explosives exposure to water.
- Water with higher levels of ammonia or nitrate (from problem areas) could be segregated and used preferentially for other construction uses.

Each contingency water management option would be site and condition-specific. These would be considered as site characteristics are encountered in the construction zones. However, as part of the planning and preparation process, specific BMPs and contingency details will be developed by NMC, and materials kept on hand to allow rapid implementation of individual management techniques, as needed. Water quality monitoring will be used to evaluate water management effectiveness of the underground BMP program. The document: *Niblack Water Quality Baseline and Site Monitoring Plan, Knight Piesold Consulting, 2007*, provides a detailed discussion of targeted state water quality criteria, monitoring program, schedule and protocol, and reporting requirements.

2.2.4 *Employee Education and Training*

Employee education and training of all site personnel will be an important component to ensuring reduced levels of ammonia and nitrates in construction drainage. The knowledge that certain practices may result in elevated concentrations in the mine effluent will help to reduce losses of explosives due to spillage. The development of a training program will help to raise awareness of construction personnel. This is an integral part of the overall Water and Explosives

Management Plan. Staff training will be conducted on a regular basis. The emphasis of the training program will be on preventative measures including:

- Water management and explosive handling practices
- Good housekeeping procedures
- Awareness of health risks of explosives used at the project
- Review of the Water and Explosives Management and BMP Plan, at least annually and after any major project modification
- Review of past incidents, causes and resulting measures used not prevent future incidents
- Incident (spills and undetonated explosives) reporting procedures
- Procedures to cleanup or mitigate incidents

Operators will be specifically trained in underground and surface water management, explosives spill prevention and control and related mitigation measures as part of MSHA training. They will be instructed in the proper procedures for storage and handling of explosives, drill hole charging and detonation practices, and procedures to follow in the event of a spill or incomplete detonation. Health and safety aspects will also be covered during training sessions.

2.2.5 *Inspections and Monitoring*

Explosives storage areas and explosives handling equipment will be inspected regularly to help reduce explosive losses. Regular inspection of drill hole charging and blasting practices will be made to determine the effectiveness of the explosives management procedures.

Water will be observed frequently at the various areas in the adit to anticipate flows from active areas with potential to produce elevated nitrogen. Observation of water sources and flows before explosives are placed will help to determine the appropriate BMP procedures to be implemented and any necessary contingency measures.

NMC will provide training for designated personnel responsible for environmental monitoring, including water quality and waste characterization. This will include appropriate short courses and/or onsite training by qualified experts. Annually, the Operations Manager and V.P. of Exploration will review site personnel qualifications to insure that appropriate training and refresher courses have occurred.

Monitoring for ammonia in mine water will be conducted periodically at various points in the construction zones, to determine potential ammonia problem areas. This testing will be incorporated into the regular water quality monitoring program for the site, which is described in the document: *Niblack Water Quality Baseline and Site Monitoring Plan, Knight Piesold Consulting, 2007*. Observations and measurements should be frequently coordinated with ongoing construction.

As-built drawings of adit construction will be maintained by NMC through the project schedule, as well as an “operating” plan. The operating plan will address: operating requirements including zone rotation criteria and schedules, maintenance requirements for the sumps, settling

basins/tanks, collection lines, land application/dispersion lines, wetlands protection berms, and any composting operation. Environmental monitoring programs will also be described. The record-keeping will also address: visual inspections and records, subsistence records, and water volume measurements. Details of the visual inspection program are described in the document: *Niblack Water Quality Baseline and Site Monitoring Plan, Knight Piesold Consulting, 2007*. NMC will prepare a detailed closure plan for the underground exploration/construction project to be submitted to ADEC in advance of closure as detailed in the Reclamation Plan that is an appendix to the *Niblack Project Underground Exploration Plan of Operations, Niblack Mining Corporation, 2007*.

Section 3. Estimated Flows and Facility Designs

3.1 Discharge Estimates

The overall water management and treatment scheme is dependent on accurate hydrologic interpretation and flow modeling. Figure 7 shows the site plan detail. This physical arrangement was “overlain” with the hydrologic criteria to determine water management volumes and ultimately water treatment needs. Peak discharge from the Niblack exploratory drift has been estimated as between 60 and 120 gallons per minute (gpm), whereas peak discharge from the PAG/ML facility is 20 gpm based on the 24 hour/25 year storm event, Combined total peak discharge to the water treatment facility from the adit and PAG/ML facility is estimated at a maximum of 140 gpm..

The peak adit discharge estimates are based on 5,890 linear feet (ft.) of tunnel approximately 13.5 ft. x 14 ft. in cross-section. The estimates were made using a transient numerical groundwater flow model assuming a tunneling rate of 20 ft. per 24 hours, mean hydraulic conductivities for the bedrock of 2.5×10^{-6} to 6.7×10^{-6} centimeters per second (cm/s), and a drainable porosity of 0.02 (Knight Piesold Consulting, December 2006). The hydraulic conductivities were first estimated by calibrating the numerical model in steady-state to groundwater elevations ranging from 50 to 1,835 ft. above mean sea level measured in five exploration boreholes. Assumed recharge values for calibrating the steady-state model were either 10% or 25% of 174 inches annual total precipitation. The lower mean hydraulic conductivity estimate and lower adit discharge estimate correspond to the lower net recharge assumption. The peak discharges occur simultaneously with advancement of the adit. Longer-term adit discharges one year after construction decline to between 45 and 110 gpm. These estimates would be used conservatively for determining potential long-term water treatment needs.

The flow rate for discharge from the PAG/ML facility is dominated by the 25-year, 24-hour design storm of 6 inches. Water flow calculations assumed that approximately one-quarter of the PAG/ML site footprint (originally estimated at 38,700 square feet) would be active at any one time, resulting in an active area of approximately 9,700 ft². Based on this, and a NRCS runoff curve number of 90, the peak discharge from the PAG/ML facility was estimated to be approximately 0.84 cubic feet per second (cfs) and the total runoff volume for the design storm was estimated to be approximately 4,100 cubic feet (ft³). Current design of the PAG/ML site contemplates a PAG/ML site with a footprint of only 25,000 ft², which will result in lower stormwater flow rates than the calculated estimate. The wastewater management system is designed based on the larger footprint and will therefore have excess capacity. This water management and water treatment scheme for the PAG/ML facility is described in detail in the document: *Niblack Industrial Solid Waste Application under the Waste Management Permit, RTR Resource Management, 2007.*

3.2 Water Management Design for Access Drift

Groundwater flows, estimated at up to 120 gallons per minute from the access drift construction, will be collected and treated in a series of treatment/water management systems. Settling pre-treatment from the underground construction would be achieved in two phases. First, water will collect near the portal exit in underground sumps for settlement of suspended solids. Secondly, all adit construction dewatering wastewater (except that which is recycled for other uses underground) would be pumped from the sumps to a 20,000 gallon Baker “frac tank” located on the surface outside the portal entrance area (http://www.bakertanks.com/ste_frac_tanks.htm).

These tanks are commonly used to settle out suspended solids in exploration projects. The steel tank is 8 ft. wide, 9 ft. high and 37 ft. long. Residence time is approximately 40 to 60 minutes, depending on flow (flow range = 100–175 gpm). About 120 gpm is the maximum estimate for underground water flow. This will allow particles of up to 0.025 mm in diameter to settle prior to conveyance to the Water Treatment Facility (WTF). Polymers can also be added to this operation to facilitate settling treatment. At least two polymer brand applications are discussed below in Section 3.5.

From the frac tank the construction wastewater would be piped to the WTF, where wastewater will mix with discharge from the PAG/ML facility in a lined holding tank prior to further treatment.

3.3 Water Management Design for Temporary PAG/ML Storage Site

An overall general facilities arrangement for the NMC operation is previously shown in Figure 5. This includes: The PAG/ML and NAG storage sites, the water treatment plant, the land application/ dispersion site, the access road, barge landing, and floating mancamp.

The PAG/ML site is designed to an engineered capacity of 16,500 yd³. The estimated volume of waste rock to be encountered is 14,300 yd³. The conceptual design for the PAG/ML site will use the following approach: (1) construct a stable foundation for this site using crushed rock; (2) cover the base with an impermeable HDPE liner to isolate the PAG/ML rock from the underlying soil and groundwater; and (3) cover the surface of the PAG/ML site with an impermeable material or liner to isolate it from precipitation (done progressively on inactive surface of PAG/ML waste pile). This approach would be used to minimize potential generation of acidic runoff or metals leaching. Run-on from up-gradient will be intercepted and diverted around the site using dispersion terraces to route the runoff into heavily vegetated forest areas or back into existing channels. Figure 9 presents pre-development conditions at the PAG/ML site. Figures 10 and 11 present design detail and water routing at the site.

The PAG/ML facility is designed such that direct precipitation and any un-diverted upland run-on water would be collected and temporarily stored in a lined detention/sediment pond at the toe

of facility. The PAG/ML site detention/settlement pond is sized to store the 4,000 ft³ of runoff from the design storm. The average daily discharge from the detention pond after the design storm is estimated to be 20 gpm. The pond will hold up to 50 gpm. Water collected in the detention/sediment pond will be pumped or gravity transported to the proposed Water Treatment Facility (WTF). Details on the WTF are described below in Section 3.5.

This siting location for the PAG/ML site assumes that the surface area of the temporary site is reasonably small, and that progressive covering of the site during operations is feasible. For purposes of this design, it is assumed that the PAG/ML site will have a footprint area of approximately 25,000 ft², and that there will be an uncovered area or ‘working face’ of 10,000 ft² or less temporarily exposed to precipitation and runoff at any time during its operation.

Figure 12 shows a schematic of the construction sequencing for the PAG/ML site developed in four phases. Following installation of the liner/geotextile system, a cushioning layer will be applied to allow for end-dumping in a north to south direction with all precipitation falling on the facility draining at a 2% grade to the low point of the pad. A diversion berm prevents all the runoff from entering the collection system. As construction of the pad continues in a north/south direction, the PAG/ML material at the most northern fringe is sealed behind the operator using Mineguard polymer sealant or other like product. This section clearly shows construction sequencing of the waste dump advancement and the “no dump” area with leak detection reporting to a collection bucket. Only freshly placed material is open to receive precipitation and water contribution to the collection and treatment system. Sections 3 and 4 on Figure 12 show the nearly completed and final temporary PAG/ML waste storage facility configurations. At this point the north to south construction sequence is complete and all PAG/ML material has been sealed.

The PAG/ML storage site is planned and designed to be temporary. At closure of the Niblack construction/exploration project, the material will be moved back underground for final reclamation. No PAG/ML material will be left above ground. This will mitigate potential surface water quality impacts.

As-built drawings of the PAG/ML temporary waste rock storage facility will be submitted to ADEC within 90 days after completion of construction. Any changes during operations that would affect performance of a “process component” will be submitted within 30 days after the completed installation.

3.4 Water Management Design for the NAG Storage Site

Runoff from the NAG site would be managed as follows: (1) minimization by diverting upland run-on around the facility and using dispersion terraces to route the runoff into heavily vegetated forest areas or back into existing channels; (2) natural infiltration through the waste pile and the highly permeable talus substrate beneath it; (3) infiltration through the forest floor between the toe of the NAG pile and the sedimentation ponds; (4) collection of surface runoff downgradient of the NAG site and intervening forest floor in sediment ponds along the upslope side of the main access road; and (5) routing to secondary sediment traps on the downslope side of the main

access road.. This approach assumes that sediment is the only contaminant of concern in the runoff from the NAG site. Site layout details are shown in Figure 7.

For purposes of this design, it is assumed that the NAG site will have a footprint area of approximately 116,000 square feet (ft²). For water management, stormwater runoff will control the sizing of treatment facilities for the NAG site. The design storm for storm runoff from the NAG site is the 25-year, 24-hour point precipitation of approximately 6.0 inches. A conservative estimate of storm runoff was calculated assuming a Natural Resources Conservation Service (NRCS) runoff curve number (CN) of 90. Runoff from the 6.0-inch design storm for a CN of 90 is 4.85 inches. Applying this runoff to the 116,000 ft² of the NAG site results in a total potential runoff volume of approximately 47,000 ft³ of water (Knight Piesold Consulting, December, 2006).

The NAG storage site is located over a talus slope northeast of the portal area (Figure 7 and 13). It is estimated that about 46,600 yd³ of waste rock material would be generated during construction. It would be built using a side hill construction approach from the bottom up at 1.5:1 to 1.3:1 as detailed in Figure 13. The permeable foundation underneath the site would further enhance infiltration. The construction technique is discussed in more detail in the document: *Niblack Project Underground Exploration Plan of Operations, Niblack Mining Corporation, 2007*. A separate stability analysis was performed by Knight Piesold as part of the design for the facility. The analysis determined these design criteria.

Stormwater BMP's are shown in the SWPPP developed for the project. This management plan was submitted to ADEC and EPA under separate cover and is included as an appendix to the *Niblack Project Underground Exploration Plan of Operations, Niblack Mining Corporation, 2007*.

3.5 Water Treatment Facility Design

The main WTF will be constructed north and east of the Niblack exploration drift. It will be designed to treat flows from the adit and stormwater from the PAG/ML temporary waste storage area (Figures 7 and 14). A two-stage pond with dimensions of 78 ft. by 78 ft. by 8 ft. deep each would be constructed immediately above the land application/attenuation sites. The water treatment facility would be sized to treat up to 6.0 inches of precipitation in 24 hours, plus the design flow. Water would be pumped from the first pond (lined) through a mixing tank for treatment, if necessary, before entering the second pond (unlined) for settling. Lime flocculant would be added to the tank to treat metals, reduce pH and enhance settling (Figure 14). All piping, chemical mix tanks, and facilities would be designed so as to allow for routing inspections for leaks. No pond overflows are planned. However, in the event of unusual or unforeseen circumstances resulting in an accidental overflow of the WTF (or at the PAG/ML facility), NMC would report such events to ADEC within one day of their occurrence.

As-built drawings of the water treatment facility will be submitted to ADEC within 90 days after completion of construction. Any changes during operations that would affect performance of a "process component" will be submitted within 30 days after the completed installation.

Internal water quality monitoring will be performed by NMC to determine whether water entering the first pond requires treatment. Similar internal water quality monitoring would take place in the second pond to evaluate treatment efficiency prior to routing to the land application system for further polishing. A valve will be installed in the pipes between the ponds and the mixing tank to allow bypass of the mixing tank if treatment is not required.

NMC has evaluated several treatment processes to treat wastewater. These are:

- settling only
- lime polymer and chemical addition (flocculant addition)
- addition of secondary filtration

Representative treatability screening results for testwork (bench-scale and pilot) done at another SE Alaska mining project for construction and stormwater drainage treatability are summarized below in Table 5.

TABLE 5. Representative Water Treatment Screening Matrix					
Process	Effectiveness	Pre-treatment Required	Relative Cost	Advantages	Disadvantages
Chemical Precipitation - Clarification					
✓ Lime	Good	No	Medium	Ease of operation, cost, stable sludge	Various optimum pH for metals
✓ Caustic	Good	No	Medium	Same + liquid	Hazardous, diff sludge
✓ Ferric chloride	Excellent	No	Medium/High	Tested	High maintenance, selective
✓ Mg(OH) ₂	Varies	No	Medium	Less hazardous liquid	Only low pH, expensive
Conventional Filter	Solids removal only	Yes	Low	Low Tech	Coarse Filter
GAC	Medium	Yes	Very High	Low tech	Limited effectiveness, regeneration
RO	Medium	Yes	Very High	Low tech	Brine disposal, membrane life

At this underground mine project, several polymers were tested for treatment efficiency. Key selection criteria were:

- Use lowest dosage possible to limit fouling.
- Adequate mixing is required.
- Use recycling and reuse, where practical.

NALCO 8852 was selected as the mineral processing coagulant and dewatering aid for the test pilot project. It was bench-scale tested and shown to improve the quality of recycled water. It also was shown to reduce solids carryover and increase the density of treatment sludge. A distribution header box was used to feed the settling tank and/or settling ponds. Complete mixing was shown to be necessary for good coagulation and settling in this test program.

Overall, both lime and ferric chloride were demonstrated to be effective settling agents at the pilot test project. The dosage was generally maintained at 0.2 – 0.4 lbs/ton, and showed good settling effects at this relatively low dosage. At the representative project, conventional filtration was also added to the circuit at a later stage of the project, once a steady state underground flow rate was achieved. This could also be employed at the Niblack site in the event monitoring programs proposed by NMC demonstrate that water quality standards are not being met using the chemical precipitation process.

Further, pilot studies conducted at the test project showed the most effective treatment process for mine construction-related drainage was the addition of ferric chloride, Betz 1100 polymer, and lime to optimize flocculation and treat varying water quality conditions likely to be encountered during construction of the portal and underground drift. While flows at the pilot testing program were much higher than anticipated for the Niblack project during testing (up to 400 gpm), the treatment scheme was proven to be effective. Costs for these chemicals are considered reasonable by NMC. NMC will conduct testwork on water samples collected from the site prior to development construction to optimize chemical dosages and treatment efficiencies. Chemical treatment and lime addition showed the following treatability results at the test project for key metals parameters:

- cadmium – 33-50% removal
- copper – 40-55% removal
- nickel – 40-55% removal
- silver – 33-50% removal
- zinc – 70-90 % removal

These parameters were selected for comparison because baseline water quality monitoring has shown that naturally-occurring conditions in Camp Creek and Waterfall Creek at Niblack may seasonally exceed Alaska water quality standards. Further monitoring is proposed to document and demonstrate these naturally-occurring conditions.

The treatment methods tested are considered appropriate for the Niblack project based on available geochemical and acid-base accounting data for the rocks in which the tunneling will

take place, and the time frame over which the project will be operational. Analysis of waste rock geochemistry and potential for metals leaching and acid generation are presented in the *Niblack Project Underground Exploration Plan of Operations, Niblack Mining Corporation, 2007* and the *Niblack Operational Characterization Plan, Knight Piesold Consulting, 2007*.

To assist determination of the relative projected water treatment needs for flows from the construction project, NMC evaluated representative water quality at the Niblack project site vs. treatability results. Treatability simulations (desk top analyses) were performed based on the pilot test work discussed above, and compared against Alaska water quality criteria, as shown in Table 6.

Table 6. Treatability Simulations for NMC Water Management Program

Key WQ Parameter	WQ Criteria^{1/} (µg/l)	Existing WQ @ Niblack (µg/l)	Treatment Efficiency	WQ (µg/l) Results^{2/}
Cadmium (Cd)	0.52	0.048	33%	0.024
Copper (Cu)	3.8	1.6	40%	0.08
Nickel (Ni)	145	1.0	40%	≅0.5
Silver (Ag)	0.37	<0.02	33%	≅0.02
Zinc (Zn)	37	<5.0	70%	≅2.5
pH		5.2	NA	NA

^{1/} Hardness dependent = Cd, Cu, Ni; Aquatic Life Chronic Criteria

^{2/} All parameters meet state WQS

The above table utilized representative water quality from all the sample sites (6 stations) at Niblack monitored between October 1996 and February 2006. This analysis was designed to take into account seasonal fluctuations. Estimated treatment efficiencies used in the simulations show that water quality will be maintained at the site. While pH was considered low for several monitoring periods, proposed water treatment will also assist with this parameter.

3.6 Land Application/Dispersion System Design

As described above in Section 3.5, the water treatment facility is designed to accommodate a combined peak flow from adit and PAG/ML facility discharge of 140 gpm. This flow rate is incorporated into the design of the land application system. Both precipitation and temperature were also considered in developing land application/dispersion criteria for the site (Table 1).

NMC has designed a land application/dispersion system for wastewater “polishing”, following underground minimization and BMP application and water treatment by settling and chemical precipitation. Four application/dispersion zones, sized at about 1.5-2 acres each, are shown in Figures 5 and 7. The total area involved is estimated at 5-7 acres. Water piped from the WTF

will be directed to the four areas through a distribution manifold. The four areas or “capture zones” include allowances for a 50-ft. setback from active waterways and inclusion of compost windrows around the downside perimeters of the zones as necessary. The compost will be 2-3 ft. high and involve spreading previously removed natural vegetation spoils in a manner that is perpendicular to the slope and application lines. Calculations for land application are shown in Appendix B. The conceptual design criteria are listed as follows:

- Peak design flow = up to 150 gpm
- Average design flow = 140 gpm
- Land application/dispersion rate = about 6.0 inches (infiltration rate) over about 5 (4-1.25 acre sites)
- Application rate using 1,400 drip emitters = 6 gallons/hr/emitter
- Application area = typically 1.25 acres depending on site geometry
- Application time = 24 hours
- Conveyance pipe = 6 inch diameter HDPE

This system would allow for 120-140 gpm on saturated, but not “flooded” forest ground at this “hydraulic limit” of the area that surrounds the application/attenuation site. The site is a wet environment with local bog-type “meadows” and “pot-hole” saturated depressions. It is heavily forested with thick undercover vegetation.

Soil application rates for disposal of treated water is based on site percolation tests performed at the site (Appendix B). As previously discussed, four percolation tests were conducted in the surficial aquifer overlying the bedrock at the site. The four percolation test values ranged from 3.2 to 24 inches per day (in/d). A design value of 6 in/d was selected for design of the drip emitter systems. Review of published literature and NRCS information suggest that land application/attenuation criteria to forested areas with silty and sandy soils ranges from 2.4 to 7.2 inches per day, which is within the proposed range for Niblack.

Land applied water will be incorporated over the area into the top layer of soil to a depth of at least 6 inches. Land that may become relatively dry in the low-precipitation or snowmelt periods of the year can be maintained in a condition that favors post-construction reclamation/rehabilitation, including the long-term creation of standing water, hydric soil conditions, and wetland-type vegetation, where feasible. For a flow of 140 gpm and a soil infiltration rate of 6 in/d, an application area of approximately 1.25 acres would be required. If a rotation of 4 days were used to rest each area, then 4 zones of about 1.25 acres each, or a total of 5.0 acres would be needed for land application of the expected peak flow of 140 gpm

Because irrigation drip emitters will be used and may plug if there are suspended solids in the water, a “bag” filter will be required at the discharge point of the WTF to remove suspended particles as a result of the lime treatment process. It is not anticipated that the drippers will plug as a result of solids dissolved in the treated water. It is estimated that approximately 1,400 drip emitters with a flow capacity of 6 gallons per hour (gph) each will be used at each zone. The emitters will be laid out in a grid pattern with distribution lines run parallel to slope.

Excess land application water is likely to be highly diluted by precipitation and snowmelt. NMC will need to be aware of storm events and visually monitor their application/distribution network on a regular basis. Excess water will be routed to a “rested” land application area and applied, if prevailing water quality dictates (meets State water quality standards). Application sites would be rotated and rested, based upon design criteria.

Section 4. Regulatory Requirements and Operating Procedures

4.1 Regulatory Requirements

Compliance with state standards at the Niblack project will be determined by the use of concurrent monitoring. ADEC criteria for concurrent monitoring are presented in Guidance for the Implementation of Natural-Condition Based Water Quality, November, 2006. In general, concurrent monitoring compares downstream sample sites against upstream sample sites that are outside the influence of human activity. Compliance points and monitoring schedule are included in the *Niblack Water Quality Baseline and Site Monitoring Plan, Knight Piesold, 2007*. Plan review of the proposed wastewater management/treatment system, including the land application/attenuation component, will be accomplished under 18 AAC 72.500 and 18 AAC 72.600.

4.2 Standard Operating Procedures

The waste water management, treatment and disposal system at Niblack will be operated according to the following “standard operating procedures” (SOP):

- **SOP # 1** – NMC will conduct visual monitoring of the entire water management area as described in the *Niblack Water Quality Baseline and Site Monitoring Plan, Knight Piesold Consulting, 2007*. This will consist of monthly formal visual checks and more frequent inspections depending upon conditions at the site. A visual monitoring form/checklist will be used for monthly checks, with regular reporting to ADEC according to an ADEC approved schedule. The primary objectives of the visual monitoring are to ensure all components of the waste water management system are operating properly, to identify damage to facilities and equipment, and to identify and mitigate potential leaks.
- **SOP # 2** – Monitoring of water quality will be performed as detailed in *Niblack Water Quality Baseline and Site Monitoring Plan, Knight Piesold Consulting, 2007*. Included in the plan is a description of compliance points for surface and ground water monitoring that will be used to ensure the treatment system is meeting regulated water quality standards.
- **SOP # 3** – NMC will conduct corrective action measures if damage to a facility is found such that environmental damage is likely to occur, or any violation of a permit condition is observed during monitoring or an inspection. Corrective action will follow measures described in the *Niblack Water Quality Baseline and Site Monitoring Plan, Knight Piesold Consulting, 2007*.
- **SOP # 4** – NMC will record adit flows and land application rates, provide water quality documentation, and conduct photo-documentation and reporting to ADEC. An example reporting form is included in Appendix C.

- **SOP # 5** – Water will not be spread or applied to land application areas when the ground infiltration capacity is totally saturated. Application areas would be rotated and “rested” based on approved operational and monitoring criteria. These rest periods are critical in preventing soil clogging and other adverse effects.
- **SOP # 6** – Water will not be applied in quantities that will adversely affect vegetation.
- **SOP # 7** – NMC will incorporate evaporative BMPs, snow and ice-making, and other water conservation practices into the overall water management strategy.
- **SOP # 8** – Any potential oils and greases from machinery at the construction site will be separated and removed as “pretreatment” using absorbent material and/or mechanical separation.
- **SOP # 9** – No water flow dispersion or diversion related to construction water management would create either a thermal barrier or flow barrier to existing anadromous fish movement, or exclusion of fish from the aquatic habitat at the site.
- **SOP # 10** – Surface water run-on and run-off would be controlled and vegetation removal at the infiltration/land dispersion site would be limited. Down-gradient berms and compost rows would be used to limit run-on and run-off from the site. Typical BMPs for limiting erosion and sedimentation are shown in *Niblack Project Underground Exploration Plan of Operations, Niblack Mining Corporation, 2007*.
- **SOP # 11** – An operational and maintenance manual will be developed for the waste water management system prior to discharge from the facility. The manual will address: water treatment methodology, monitoring and maintenance of the collection and piping system, monitoring and maintenance of the frac tank and mixing tanks, monitoring and maintenance of holding ponds and sediment ponds, zone rotation of application areas, composting requirements, and environmental monitoring and protocol.
- **SOP # 12** – Upon completion of these temporary construction activities (within 90 days after cessation), NMC will submit to ADEC a “completion report” including:
 - ✓ total construction and adit water applied (mg)
 - ✓ acre-inches per acre applied
 - ✓ dewatering program water quality monitoring results, including up and down gradient sites
 - ✓ summary of potential effects of temporary land application on local land, vegetation, and water resources
 - ✓ photo-documentation of temporary program results, efficiencies, potential environmental issues
 - ✓ submittal of appropriate land application reporting forms (Appendix C).

Wastewater from the project will be managed so as not to create a public health hazard or nuisance, or impact existing or future beneficial uses of ground and surface water. No underground sources of drinking water (SDWA) are located within one mile of the project land application/attenuation site. The temporary land application area would be authorized by ADEC rule for the construction, operation, maintenance, or abandonment of the facility. The authorization will be conditioned by stringent performance standards for the planned short-term (less than 24 months) period of operation. The land system will be bonded as part of the overall project reclamation financial assurance.

Reclamation of the waste water management, treatment and disposal system will be as outlined in the Reclamation Plan that is an appendix to the *Niblack Project Underground Exploration Plan of Operations, Niblack Mining Corporation, 2007*. A bond estimate is included in the Reclamation Plan.

Section 5. References

- Alaska Department of Environmental Conservation, 2003a 18 AAC 70, Water Quality Standards, June, 2003.
- Alaska Department of Environmental Conservation, 2003b. *Alaska Water Quality Criteria Manual for Toxic and Other Deleterious Organic and Inorganic Substances*, May 15, 2003.
- Anderson, K. 1993. *Ground Water Handbook*. National Ground Water Association; Dublin, Ohio, 401 pp.
- HDR Alaska, Inc., 2006. *Niblack Property Prince of Wales Island, Alaska Preliminary Jurisdictional Determination*.
- Knight Piesold Consulting, 2007. *Niblack Project Water Quality Baseline and Site Monitoring Plan*
- Knight Piesold Consulting, 2007. *Niblack Project Operational Characterization Plan*.
- Knight Piesold Consulting, 2006. *Estimation of Ground Water and Surface Water Flows for the Niblack Construction/Exploration Project*. (C. Conrad and J. Kunkel)
- Knight Piesold Consulting, 2006. *Geotechnical Summary of the Niblack Project Waste Rock Dumps*.
- Knight Piesold, 2006. *Preliminary Hydrologic/Water Quality Report for Niblack Project, Alaska*.
- Miller, J.F., 1963. *Probable Maximum Precipitation and Rainfall-Frequency Data for Alaska for Areas of 400 Square Miles, Durations to 24 Hours and Return Periods of 1 to 100 Years*, Technical Paper No. 47, U.S. Department of Commerce.
- RTR Resource Management, Inc., 2007. *Niblack Industrial Solid Waste Landfill Application Under the Waste Management Permit*.
- RTR Resource Management, Inc., 2007. *Reclamation Plan for the Niblack Underground Exploration Project*.
- RTR Resource Management, Inc., 2006. *Niblack Stormwater Pollution Prevention Plan*.
- U.S. Environmental Protection Agency, 2005. *List of Drinking Water Contaminants and MCLs, National Secondary Drinking Water Regulations*; www.epa.gov/safewater/mcl.html.

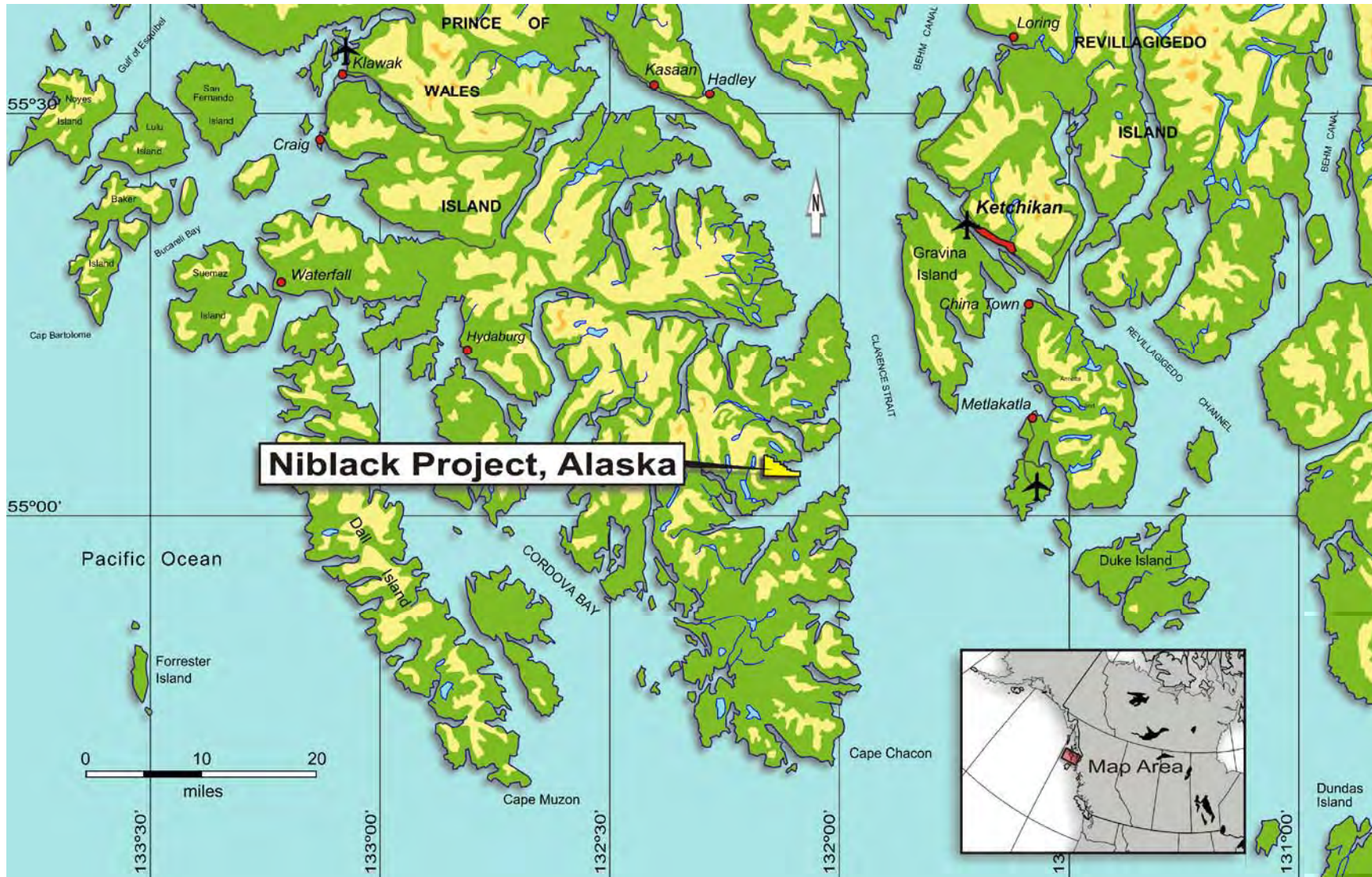

Niblack Project, Alaska



NIBLACK MINING CORP.		
PROPOSED EXPLORATION PROGRAM		
LOCATION MAP		
<i>Knight Piésold</i> CONSULTING	PROJECT/ASSIGNMENT NO. VA102-205/2	REF. NO. VA07-00492
	FIGURE 1	
		REV. 0

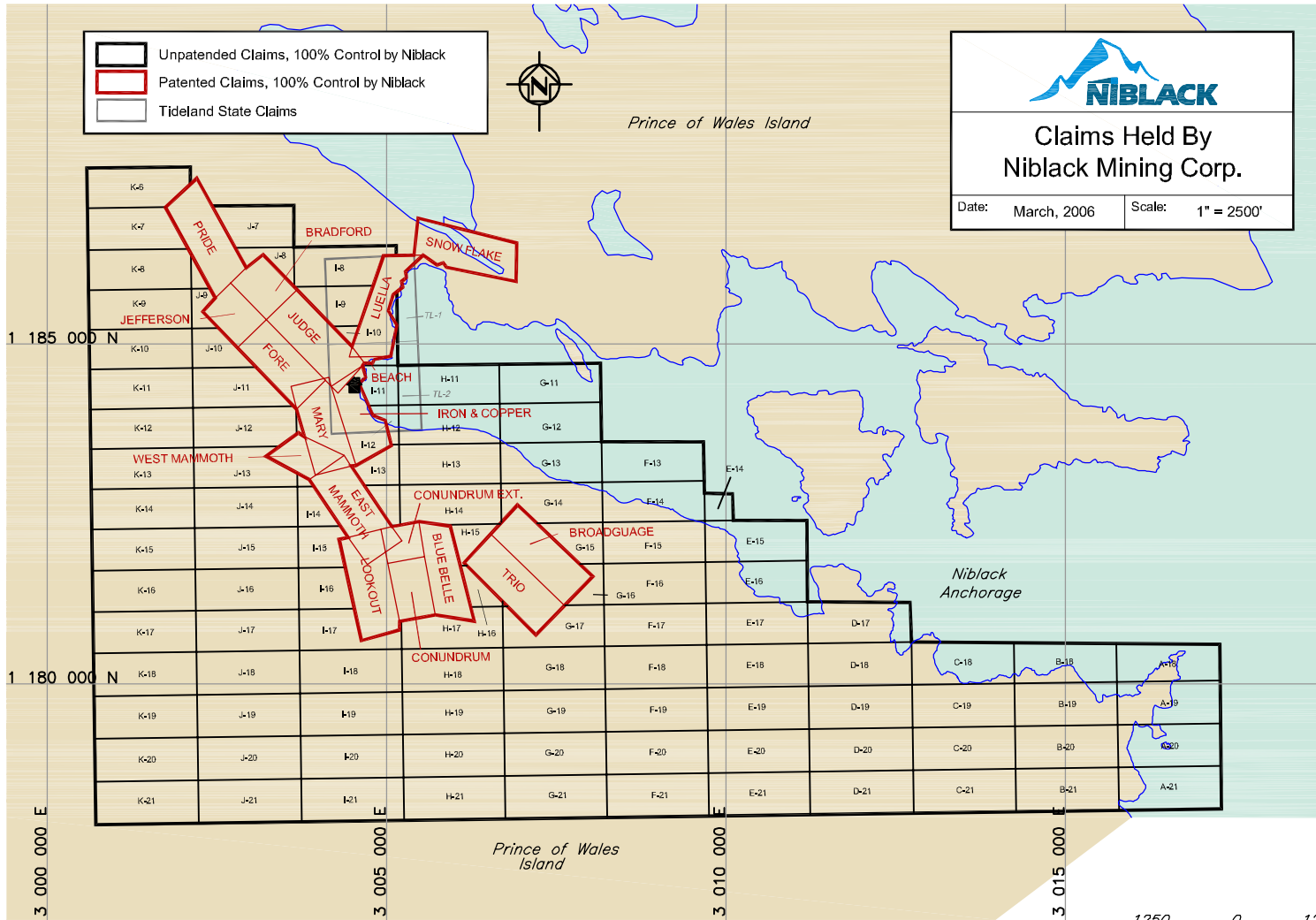

**Claims Held By
Niblack Mining Corp.**

Date: March, 2006 Scale: 1" = 2500'

PROJECTION: NAD 27 US, ALASKA STATE PLANE ZONE 1 (FEET)

REV. 0 13APR'07 ISSUED IN FINAL

NIBLACK MINING CORP.		
PROPOSED EXPLORATION PROGRAM		
CLAIMS MAP		
	PROJECT/ASSIGNMENT NO. VA102-205/2	REF. NO. VA07-00492
	FIGURE 2	
		REV. 0

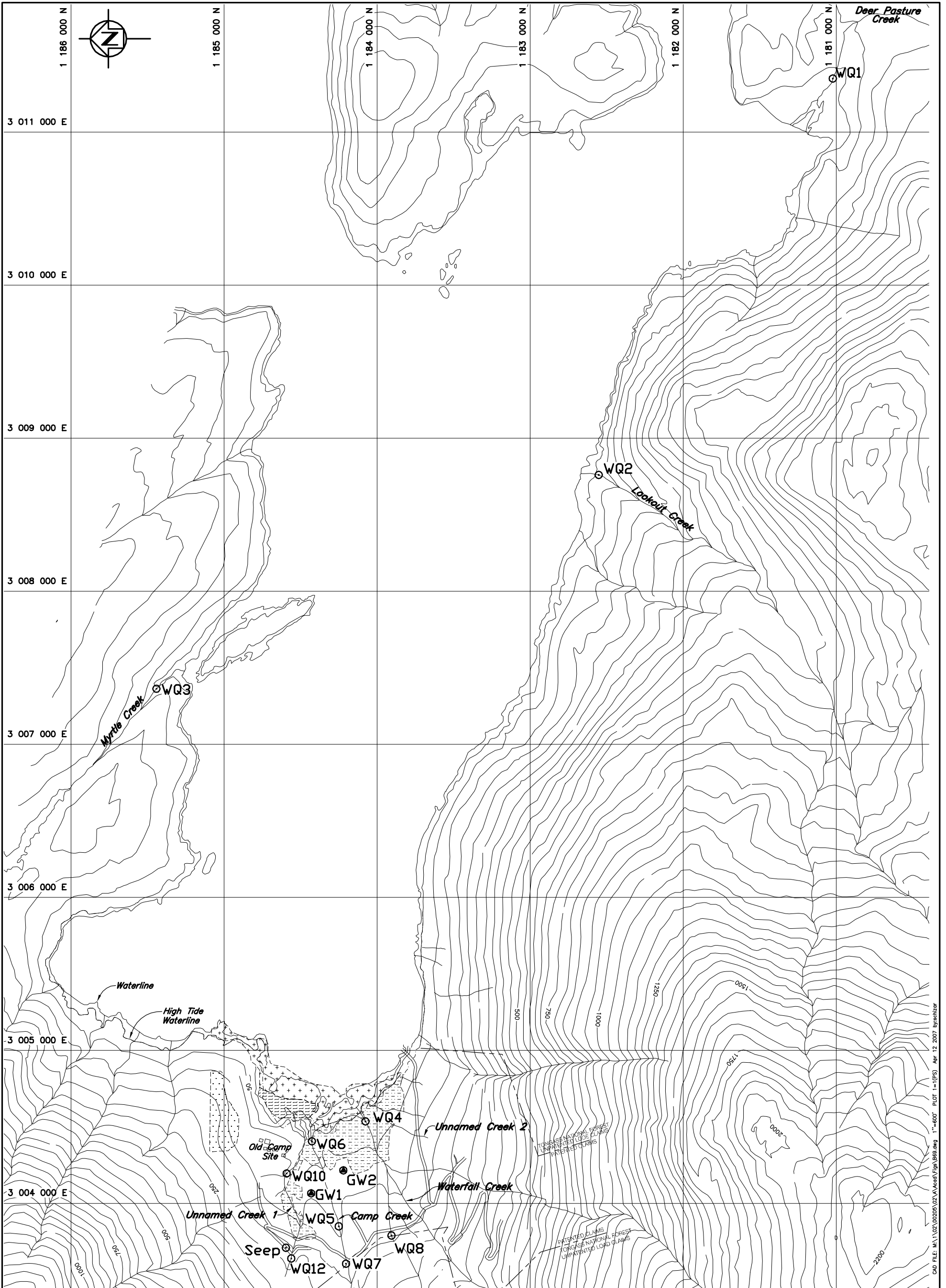

LEGEND

- Baseline GW Site
- Baseline Water Quality Station
- E1UBL Estuarine - Subtidal
- ⊕ E2US1N Estuarine - Unvegetated Intertidal

- ▨ PFO-SS4B - Needleleaf Forest/Scrub-Shrub Wetland
- ▨ PFO4B - Needleleaf Forest Wetland
- ▨ E2EM1P Estuarine - Emergent Intertidal

NOTES

1. This figure produced from information provided by Beacon Hill Consultants (1988) Ltd.
2. All dimensions and elevations are in feet unless otherwise noted.

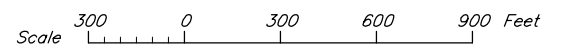

NIBLACK MINING CORP.		
PROPOSED EXPLORATION PROGRAM		
BASELINE WATER QUALITY STATIONS		
<i>Knight Piésold</i> CONSULTING		PROJECT/ASSIGNMENT NO. VA102-205/2
		REF. NO. VA07-00492
FIGURE 3		REV. 0

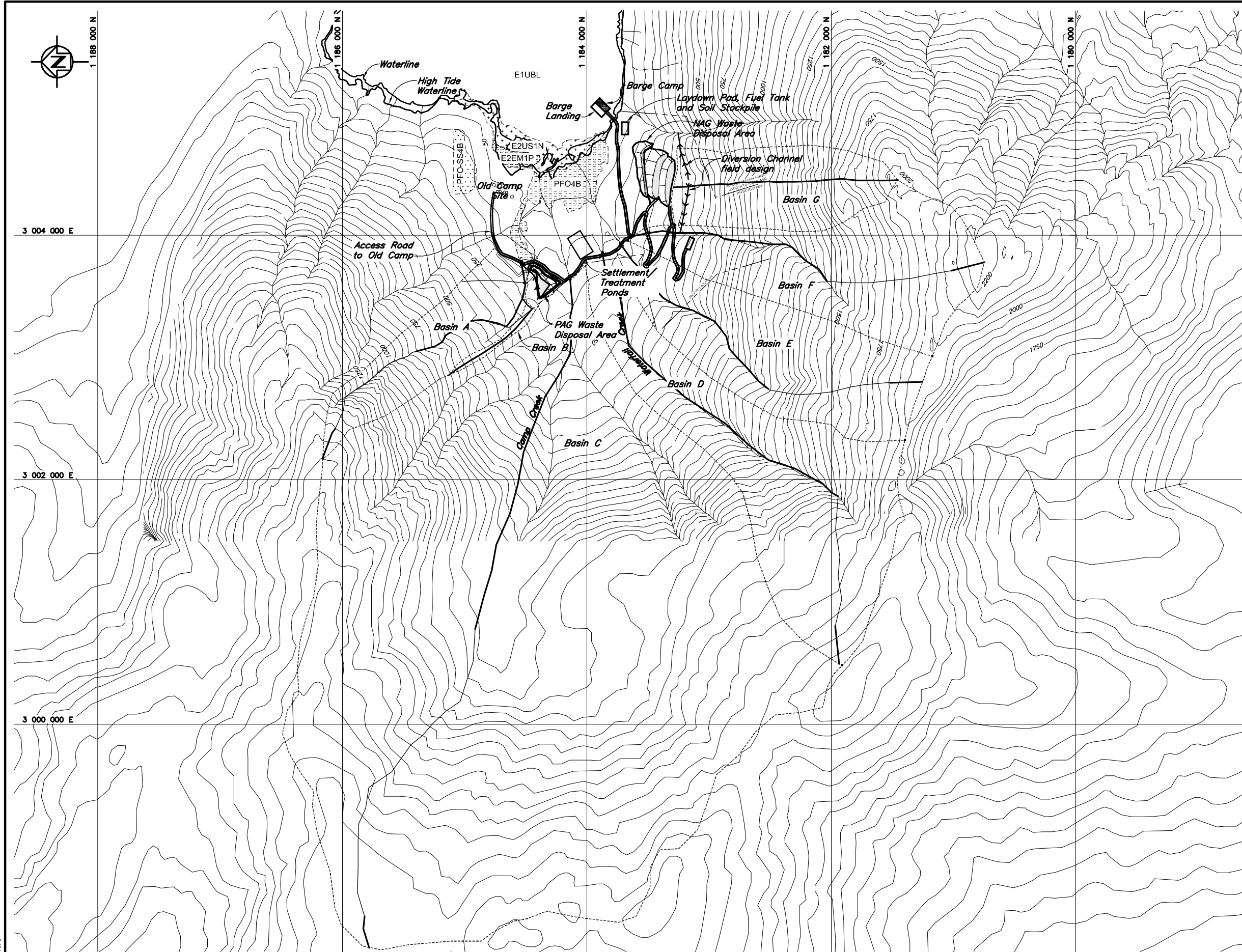

LEGEND

- E1UBL Estuarine - Subtidal
- E2US1N Estuarine - Unvegetated Intertidal
- E2EM1P Estuarine - Emergent Intertidal
- PFO-SS4B - Needleleaf Forest/Scrub-Shrub Wetland
- PFO4B - Needleleaf Forest Wetland
- Drainage Basin Boundary

NOTES

1. Offsite topography from USGS Craig A-1 15 minute quadrangle.
2. All dimensions and elevations are in feet unless otherwise noted.

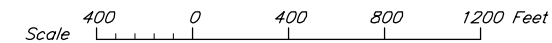

SITE PLAN

XREF FILE : TOPO

REV. 0 13APR'07 ISSUED IN FINAL

NIBLACK MINING CORP.	
PROPOSED EXPLORATION PROGRAM	
MAJOR DRAINAGE BASINS	
Knight Piésold CONSULTING	
PROJECT/ASSIGNMENT NO. VA102-205/2	REF. NO. VA07-00492
FIGURE 4	
	REV. 0

CAD FILE: W:\1\02\00205\02\VA102-205\02\VA102-205.dwg 1"=800' PLOT: 1-1 (PS) Apr 12 2007 By: schizer

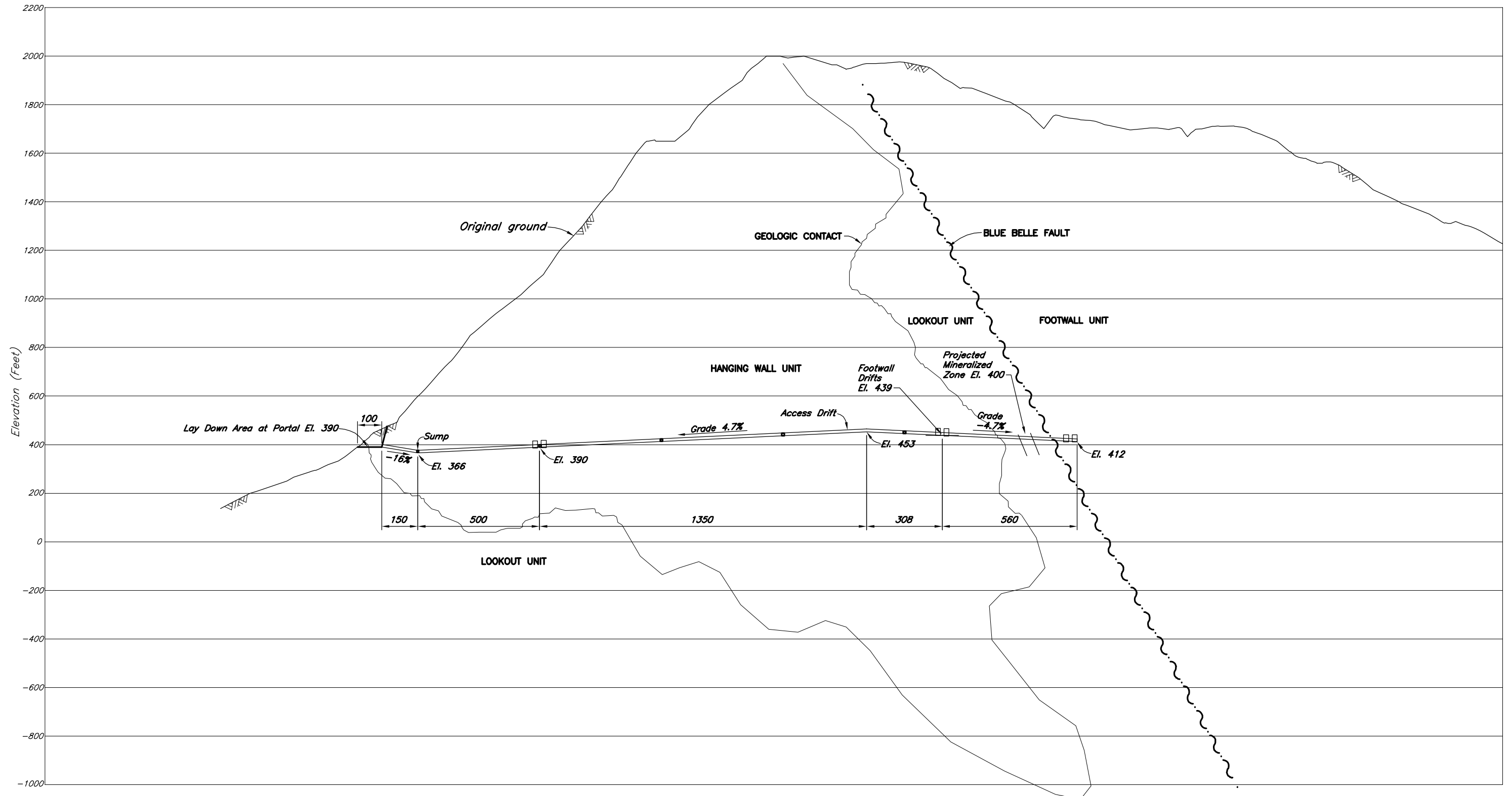

SECTION 1
FIG. 5
LOOKING EAST

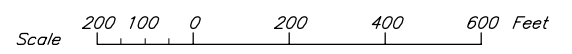





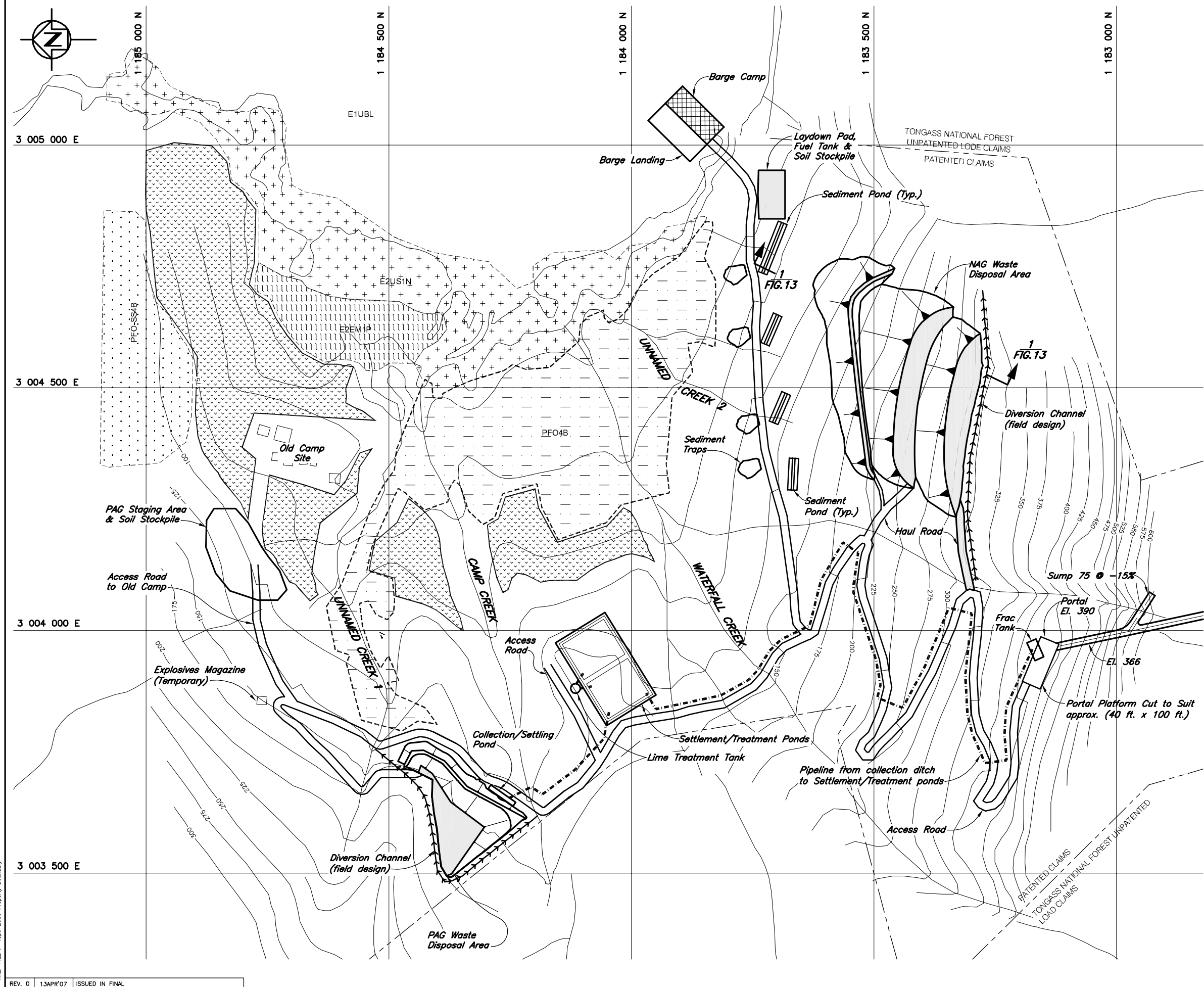

NOTES
 1. This figure produced from information provided by Beacon Hill Consultants (1988) Ltd.
 2. All dimensions and elevations are in feet unless otherwise noted.

NIBLACK MINING CORP.	
PROPOSED EXPLORATION PROGRAM	
PROPERTY SECTION	
Knight Piésold CONSULTING	PROJECT/ASSIGNMENT NO. VA102-205/2
REF. NO. VA07-00492	REV. 0
FIGURE 6	



LEGEND

-  E1UBL Estuarine - Subtidal
-  E2US1N Estuarine - Unvegetated Intertidal
-  E2EM1P Estuarine - Emergent Intertidal
-  PFO-SS4B - Needleleaf Forest/Scrub-Shrub Wetland
-  PFO4B - Needleleaf Forest Wetland
-  Land Application Areas
-  Property Boundary

NOTE

All dimensions and elevations are in feet unless otherwise noted.

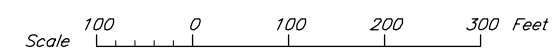

NIBLACK MINING CORP.	
PROPOSED EXPLORATION PROGRAM	
SITE PLAN DETAIL	
<i>Knight Piésold</i> CONSULTING	PROJECT/ASSIGNMENT NO. VA102-205/2
REF. NO. VA07-00492	REV. NO. 0
FIGURE 7	

XREF FILE : Topo 2006 Property Boundary

REV. 0 13APR'07 ISSUED IN FINAL

CAD FILE: M:\1\02\00205\02\A\Kearf\Fig\1864.dwg 1"=200' PLOT 1=100' Apr 12 2007 by:ashizer

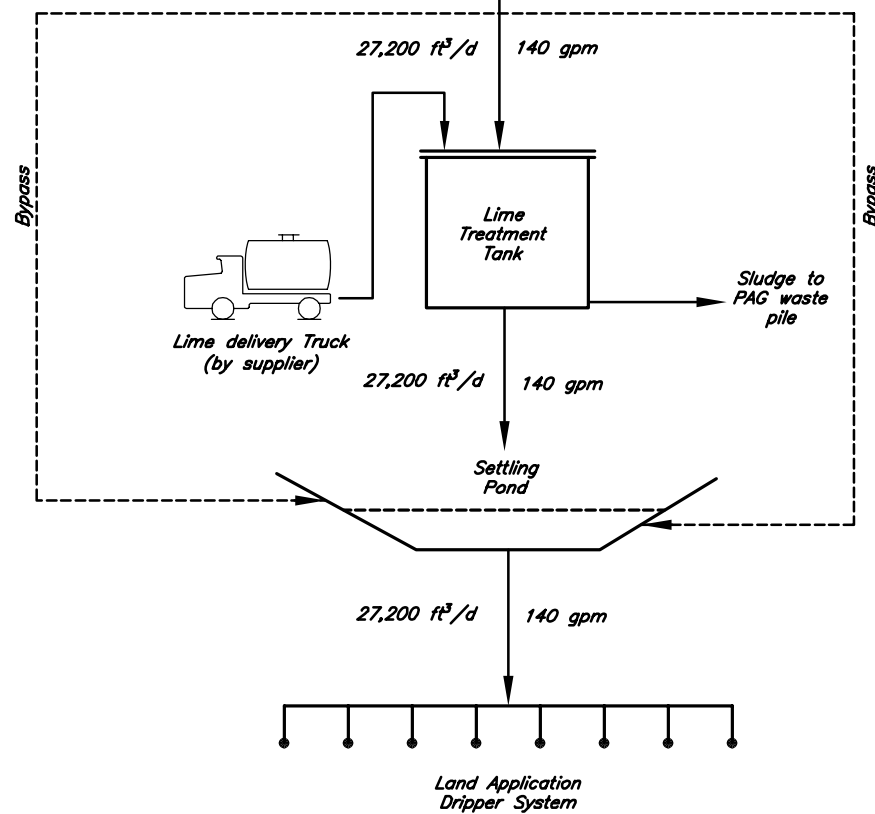
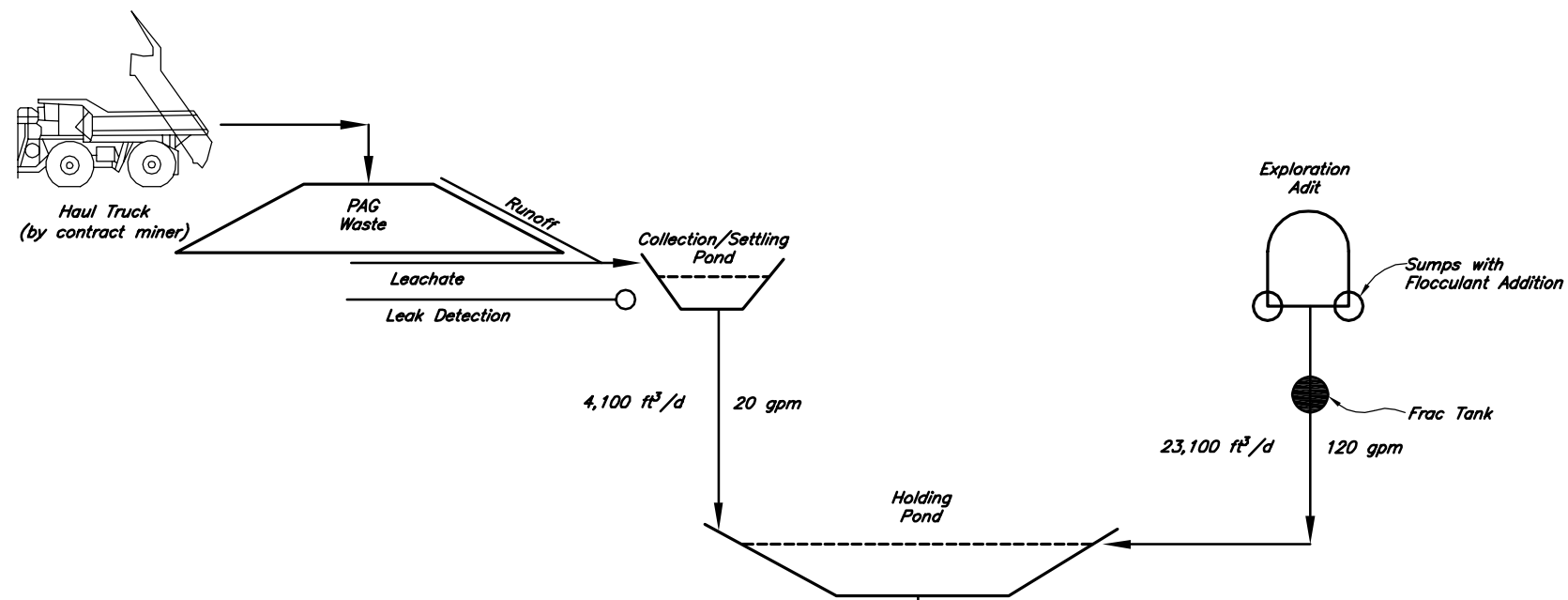

PAG/ADIT WATER TREATMENT

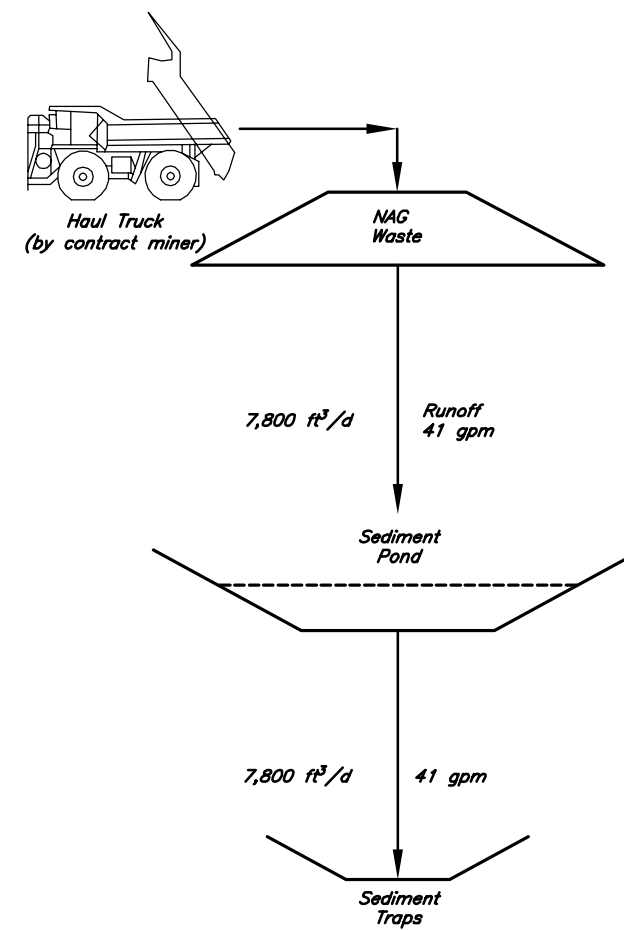

NAG WASTE WATER MANAGEMENT

NOTE
 1. All values are average values for one day.

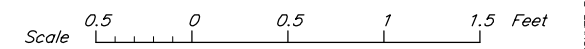

NIBLACK MINING CORP.		
PROPOSED EXPLORATION PROGRAM		
WASTE WATER COLLECTION AND TREATMENT CONCEPTS		
Knight Piésold CONSULTING	PROJECT/ASSIGNMENT NO. VA102-205/2	REF. NO. VA07-00492
	FIGURE 8	

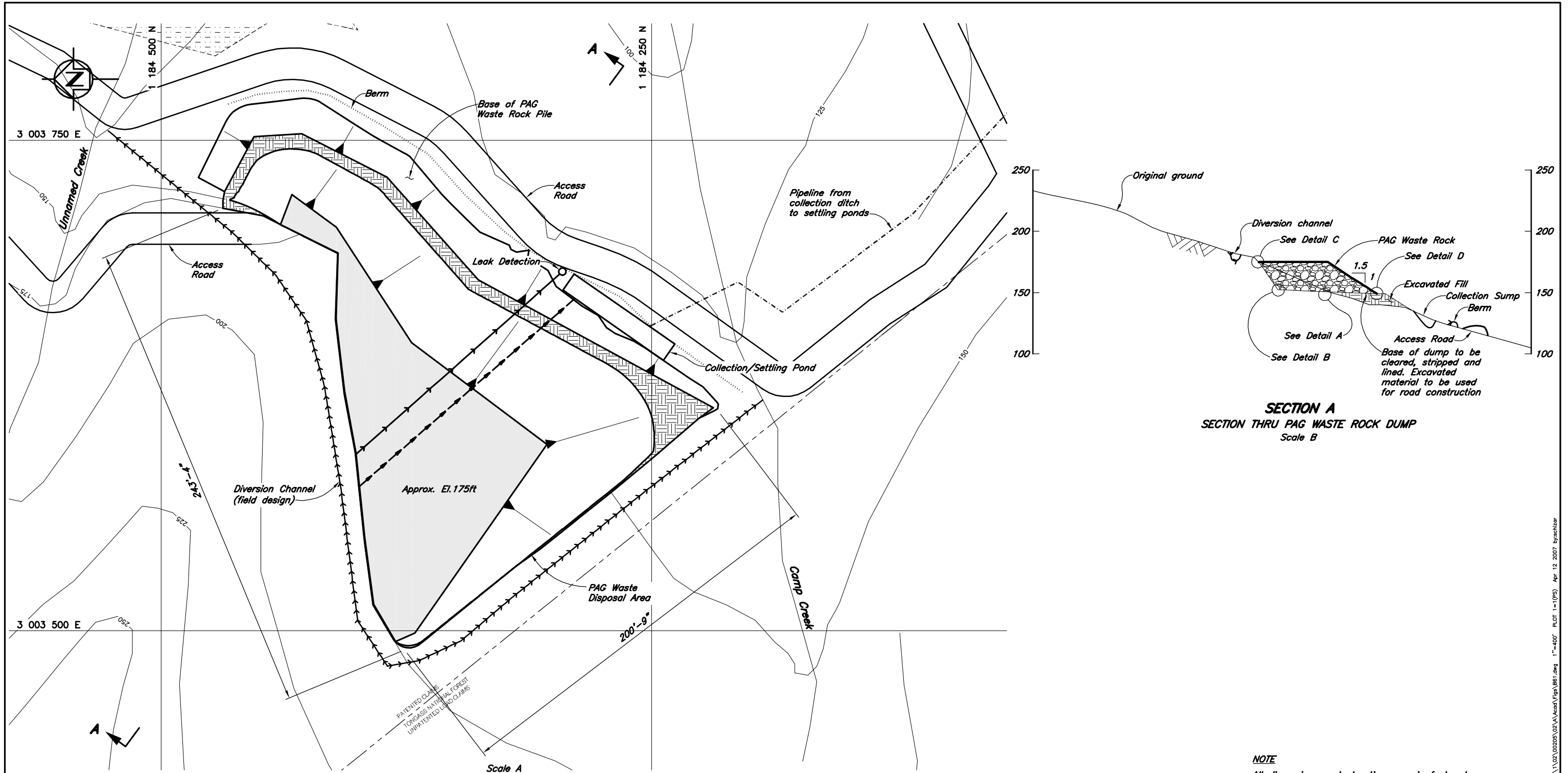

SECTION A
SECTION THRU PAG WASTE ROCK DUMP
Scale B

NOTE
All dimensions and elevations are in feet unless otherwise noted.

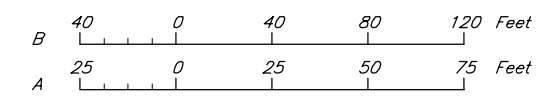

- LEGEND**
- E1UBL Estuarine - Subtidal
 - E2US1N Estuarine - Unvegetated Intertidal
 - E2EM1P Estuarine - Emergent Intertidal
 - PFO-SS4B - Needleleaf Forest/Scrub-Shrub Wetland
 - PFO4B - Needleleaf Forest Wetland
 - Property Boundary

XREF FILE : Hydro_Features_Topo

REV. 0 13APR'07 ISSUED IN FINAL

CAD FILE: W:\1\02\00205\205\A\Waste\FigA\B61.dwg 1"=400' PLOT: 1"=400' Apr 12 2007 by:ashizer

NIBLACK MINING CORP.							
PROPOSED EXPLORATION PROGRAM							
PAG WASTE ROCK PILE DESIGN DETAIL AND WATER ROUTING							
Knight Piésold CONSULTING	<table border="1"> <tr> <td>PROJECT/ASSIGNMENT NO. VA102-205/2</td> <td>REF. NO. VA07-00492</td> </tr> <tr> <td colspan="2" style="text-align: center;">FIGURE 10</td> </tr> <tr> <td>REV. 0</td> <td></td> </tr> </table>	PROJECT/ASSIGNMENT NO. VA102-205/2	REF. NO. VA07-00492	FIGURE 10		REV. 0	
PROJECT/ASSIGNMENT NO. VA102-205/2	REF. NO. VA07-00492						
FIGURE 10							
REV. 0							

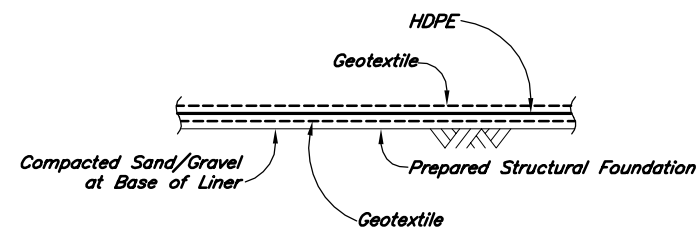

DETAIL A
TYPICAL LINER BASE
NTS

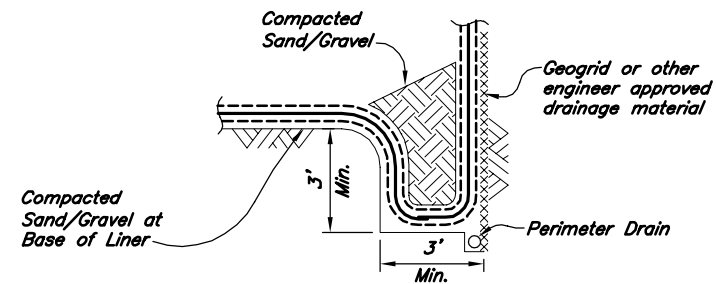

DETAIL B
LINER ANCHOR
(BACK FACE OF PAG
WASTE ROCK DUMP)
NTS

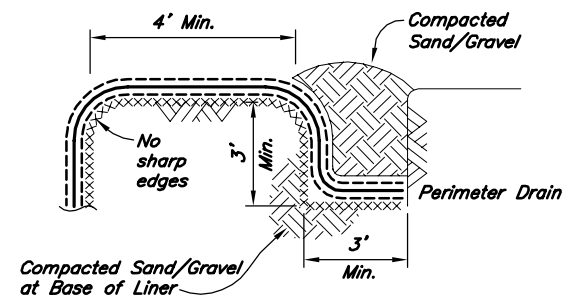

DETAIL C
LINER ANCHOR
(CREST OF BACK FACE OF
PAG WASTE ROCK DUMP)
NTS

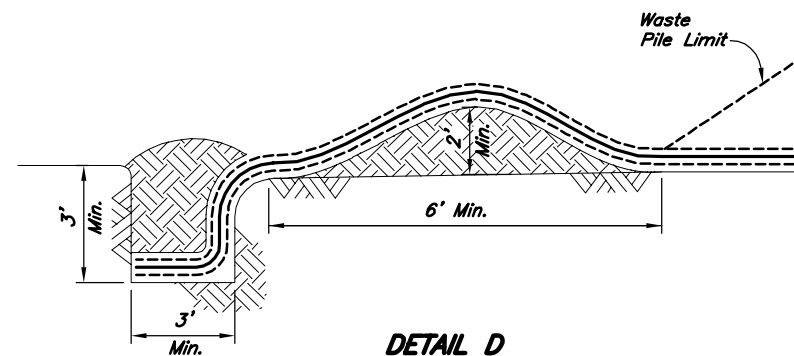

DETAIL D
LINER ANCHOR
(TOE OF PAG WASTE
ROCK DUMP)
NTS

LEGEND

- Geotextile
- HDPE Liner
- xxxxxxx Geogrid Drainage Layer

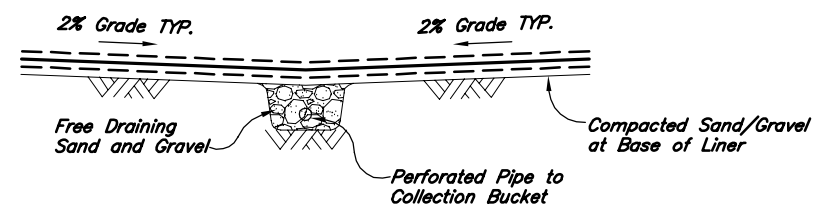

DETAIL E
LEAK DETECTION
(CENTER OF PAG
WASTE ROCK DUMP)
NTS

NIBLACK MINING CORP.	
PROPOSED EXPLORATION PROGRAM	
PAG LINER DETAILS	
Knight Piésold CONSULTING	PROJECT/ASSIGNMENT NO. VA102-205/2
	REF. NO. VA07-00492
FIGURE 11	REV. 0

PHASE 1 (NTS)

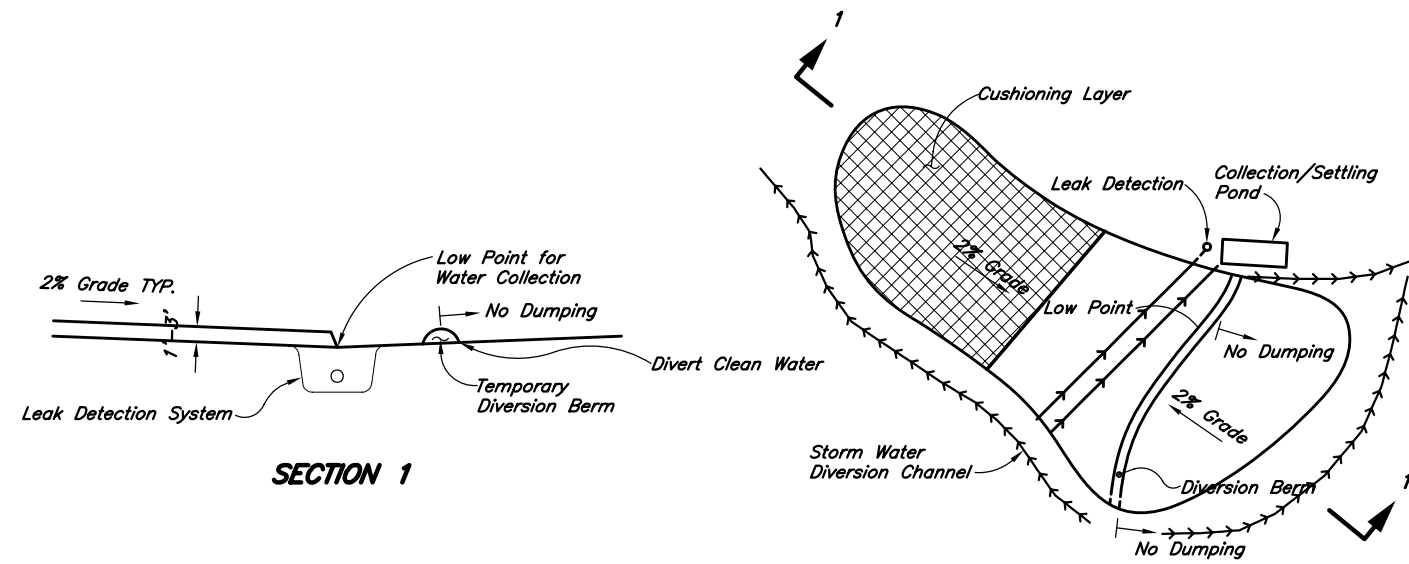

PHASE 2 (NTS)

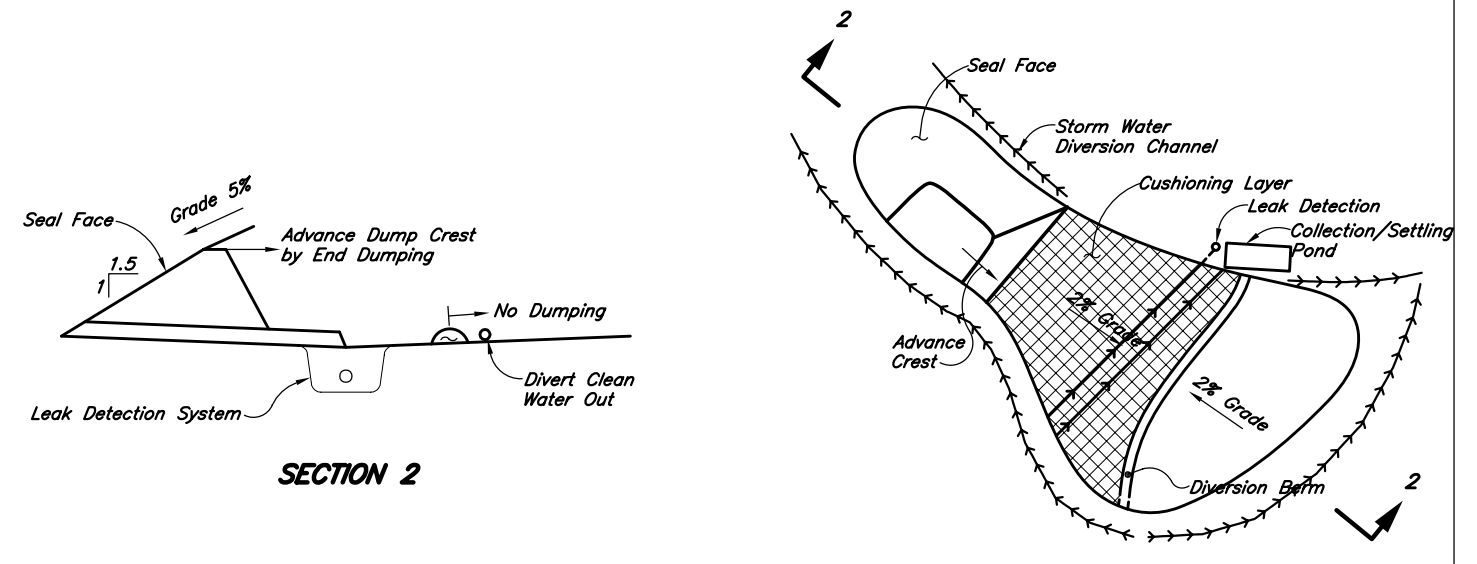

PHASE 3 (NTS)

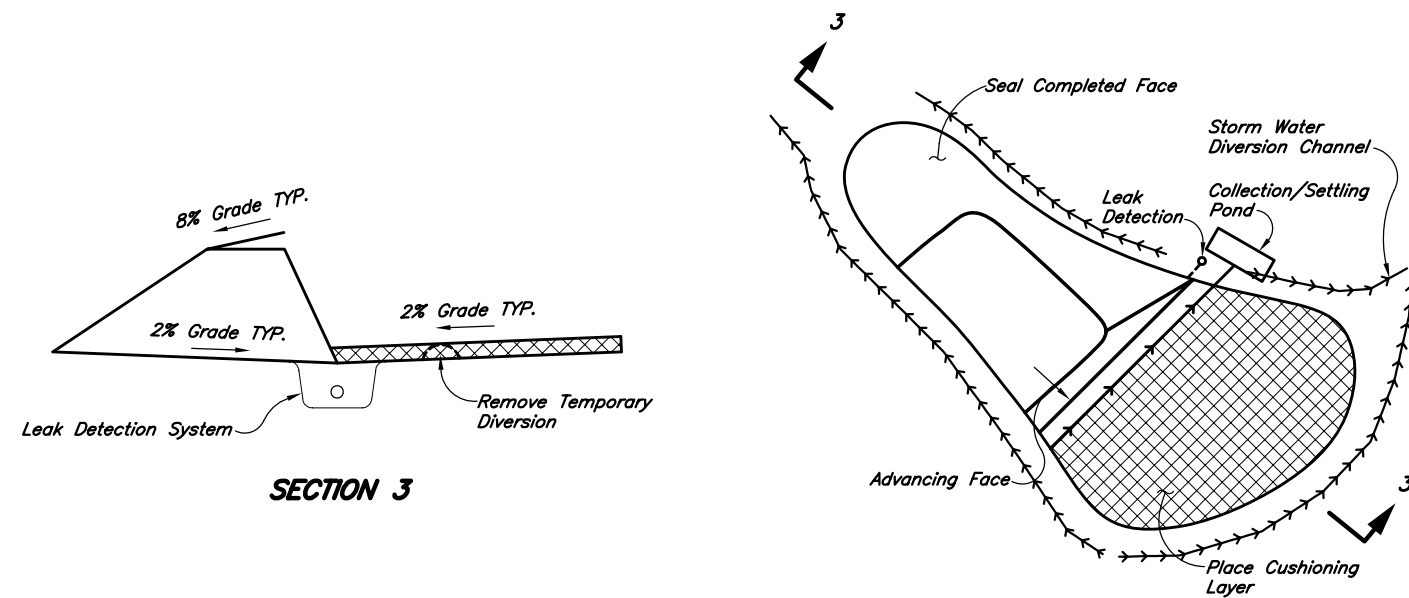

PHASE 4 (NTS)

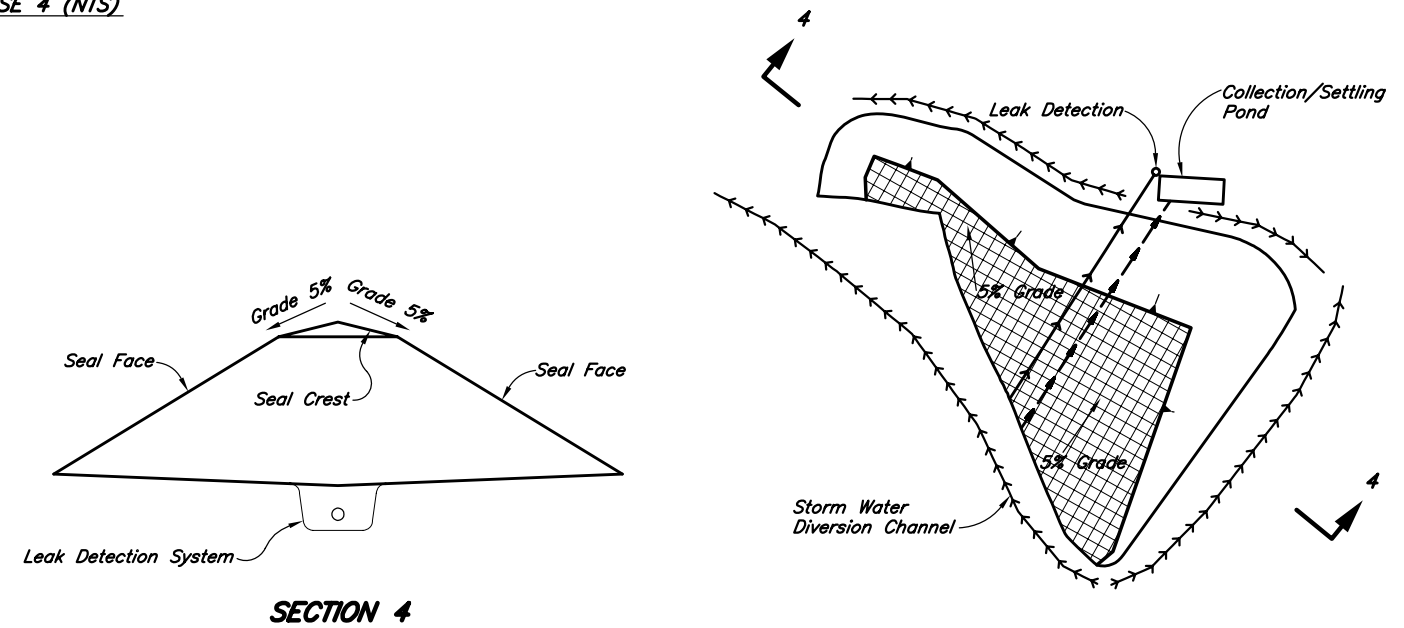

XREF FILE : Hydro_Feature_Topo

WACOUMER, B.C. CAD FILE: H:\1\02\00205\02\A\Acad\Fig\B62.dwg 1"=400' PLOT 1=1 (PS) Apr 12 2007 by:rschizer

NIBLACK MINING CORP.							
PROPOSED EXPLORATION PROGRAM							
PAG WASTE ROCK PILE CONSTRUCTION SEQUENCE AND WATER ROUTING SCHEMATIC							
Knight Piésold CONSULTING	<table border="1"> <tr> <td>PROJECT/ASSIGNMENT NO. VA102-205/2</td> <td>REF. NO. VA07-00492</td> </tr> <tr> <td colspan="2" style="text-align: center;">FIGURE 12</td> </tr> <tr> <td>REV. 0</td> <td>REV. 0</td> </tr> </table>	PROJECT/ASSIGNMENT NO. VA102-205/2	REF. NO. VA07-00492	FIGURE 12		REV. 0	REV. 0
PROJECT/ASSIGNMENT NO. VA102-205/2	REF. NO. VA07-00492						
FIGURE 12							
REV. 0	REV. 0						

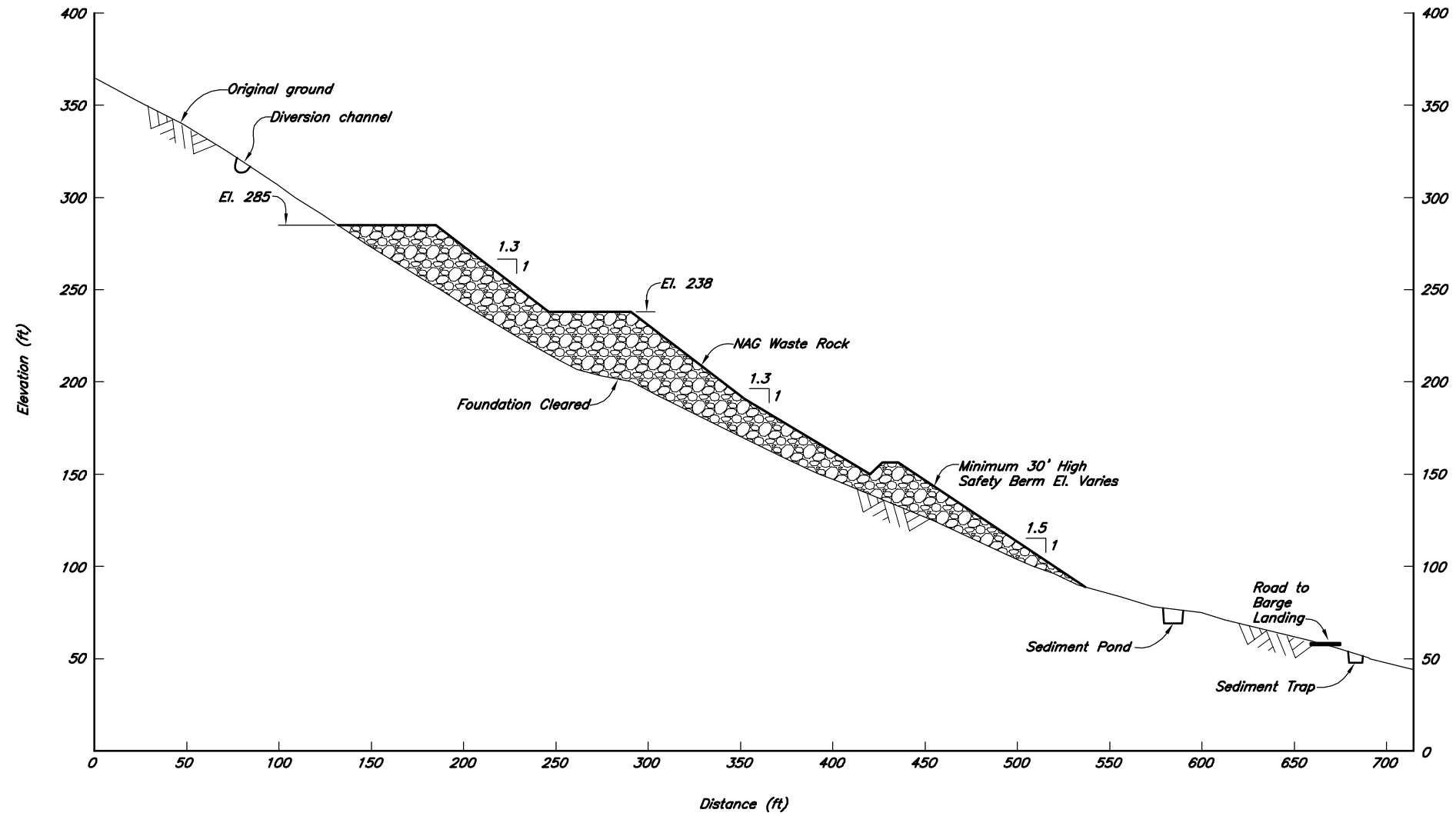

SECTION $\frac{1}{7}$
SECTION THRU NAG WASTE ROCK DUMP

NOTE
1. All dimensions and elevations are in feet unless otherwise noted.

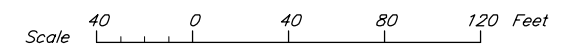

NIBLACK MINING CORP.	
PROPOSED EXPLORATION PROGRAM	
NAG WASTE ROCK DUMP SECTION DETAILS	
Knight Piésold CONSULTING	PROJECT/ASSIGNMENT NO. VA102-205/2
	REF. NO. VA07-00492
FIGURE 13	REV. 0



PONDS INNER FACE 1.5:1 SLOPE
 PONDS OUTER FACE 2.5:1 SLOPE

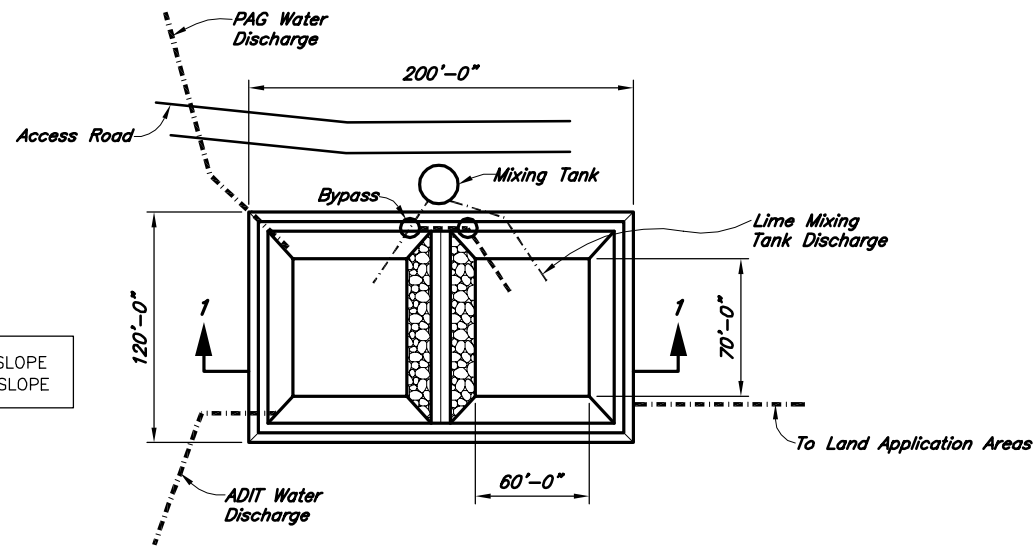

SETTLEMENT/TREATMENT PONDS PLAN

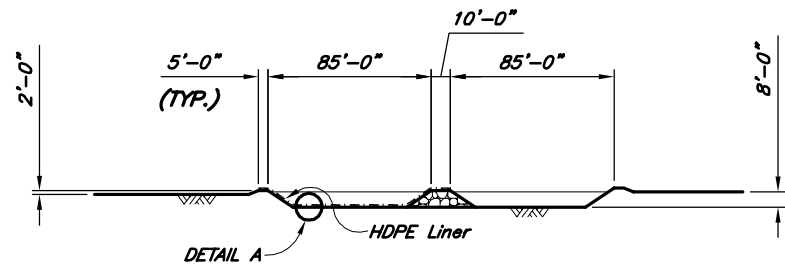

SECTION 1

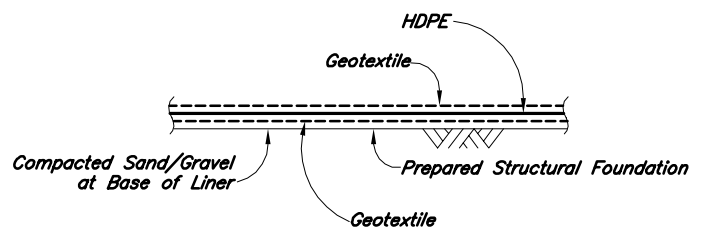

**DETAIL A
 TYPICAL LINER BASE
 NTS**

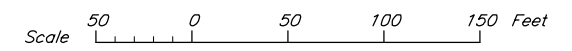

NIBLACK MINING CORP.	
PROPOSED EXPLORATION PROGRAM	
SETTLEMENT/TREATMENT POND SECTION	
Knight Piésold CONSULTING	PROJECT/ASSIGNMENT NO. VA102-205/2
	REF. NO. VA07-00492
FIGURE 14	REV. 0

APPENDIX A

CALCULATIONS FOR STORMWATER DRAINAGE STRUCTURES AND CULVERTS

(Pages A1 to A5)

tmp#20.txt

TR-55 Tabular Hydrograph Method
Input Summary

Description
 Basin A--No. of PAG, 5-in precip
 Rainfall Distribution Type I
 Ia/P Interpolation On
 Total Area 21.13 ac

 Peak Time 10.20 hrs
 Peak Flow 12.14 cfs

Given Input Data:

Subarea Description	D/S Subareas	Area (ac)	CN	Tc (hrs)	Tt (hrs)	Rainfall (in)
Basin A		21.13	60	0.21	0.00	5.00

Support Data:

tmp#14.txt

TR-55 Tabular Hydrograph Method
Input Summary

Description
 Basin B--PAG Offsite, 5-in precip
 Rainfall Distribution Type I
 Ia/P Interpolation On
 Total Area 1.18 ac

 Peak Time 10.10 hrs
 Peak Flow 0.89 cfs

Given Input Data:

Subarea Description	D/S Subareas	Area (ac)	CN	Tc (hrs)	Tt (hrs)	Rainfall (in)
Basin B		1.18	60	0.10	0.00	5.00

Support Data:

tmp#15.txt

TR-55 Tabular Hydrograph Method
Input Summary

Description
 Basin C--Camp Creek, 5-in precip
 Rainfall Distribution Type I
 Ia/P Interpolation On
 Total Area 359.00 ac

 Peak Time 10.20 hrs
 Peak Flow 206.17 cfs

Given Input Data:

Subarea Description	D/S Subareas	Area (ac)	CN	Tc (hrs)	Tt (hrs)	Rainfall (in)
Basin C		359.00	60	0.20	0.00	5.00

Support Data:

tmp#16.txt

TR-55 Tabular Hydrograph Method
Input Summary

Description
 Basin D--N. Waterfall Cr., 5-in precip
 Rainfall Distribution Type I
 Ia/P Interpolation On
 Total Area 65.13 ac

 Peak Time 10.20 hrs
 Peak Flow 37.40 cfs

Given Input Data:

Subarea Description	D/S Subareas	Area (ac)	CN	Tc (hrs)	Tt (hrs)	Rainfall (in)
Basin D		65.13	60	0.19	0.00	5.00

Support Data:

tmp#17.txt

TR-55 Tabular Hydrograph Method
Input Summary

Description
 Basin E--S. Waterfall Cr., 5-in precip
 Rainfall Distribution Type I
 Ia/P Interpolation On
 Total Area 43.59 ac

 Peak Time 10.20 hrs
 Peak Flow 25.03 cfs

Given Input Data:

Subarea Description	D/S Subareas	Area (ac)	CN	Tc (hrs)	Tt (hrs)	Rainfall (in)
Basin E		43.59	60	0.19	0.00	5.00

Support Data:

tmp#18.txt

TR-55 Tabular Hydrograph Method
Input Summary

Description
 Basin F--Portal, 5-in precip
 Rainfall Distribution Type I
 Ia/P Interpolation On
 Total Area 45.91 ac

 Peak Time 10.20 hrs
 Peak Flow 26.37 cfs

Given Input Data:

Subarea Description	D/S Subareas	Area (ac)	CN	Tc (hrs)	Tt (hrs)	Rainfall (in)
Basin F		45.91	60	0.22	0.00	5.00

Support Data:

tmp#19.txt

TR-55 Tabular Hydrograph Method
Input Summary

Description
 Basin G--NAG Offsite, 5-in precip
 Rainfall Distribution Type I
 Ia/P Interpolation On
 Total Area 24.58 ac

 Peak Time 10.10 hrs
 Peak Flow 18.48 cfs

Given Input Data:

Subarea Description	D/S Subareas	Area (ac)	CN	Tc (hrs)	Tt (hrs)	Rainfall (in)
Basin G		24.58	60	0.13	0.00	5.00

Support Data:

Niblack Time of Concentration Calculations			Basin A	Basin B	Basin C	Basin D	Basin E	Basin F	Basin G
			No. of PAG	PAG	Camp Cr.	N. Waterfall Cr.	N. Waterfall Cr.	Portal	NAG
Basin Area	Desc	Units	21.13	1.18	359	65.13	43.59	45.91	24.58
		acres							
Sheet Flow									
RCN			60	60	60	60	60	60	65
Mannings n		n/a	0.24	0.24	0.24	0.24	0.24	0.24	0.24
Begin Elev		ft	1800	710	2557	2325	2000	2200	2000
End Elev		ft	1700	625	2400	2050	1900	2125	1950
L	flow length	feet	266	114	262	313	266	281	152
P2	2-yr 24-hr rain	inches	5	5	5	5	5	5	4
s	slope	ft/ft	0.38	0.75	0.60	0.88	0.38	0.27	0.33
Tt	Travel time	hr	0.13	0.05	0.11	0.10	0.13	0.15	0.10
Shallow Conc--Trapezoidal									
Mannings n			0.045	0.045	0.045	0.045	0.045	0.045	0.045
Begin Elev		ft	1700	625	2400	2050	1900	2125	1950
End Elev.		ft	800	215	955	1575	1050	1300	265
Flow Depth		feet	0.1	0.1	0.6	0.3	0.19	0.19	0.2
Bottom Width		ft	8	2	8	8	8	8	10
Side Slopes		H:V	4.0	4.0	4.0	4.0	4.0	4.0	4.0
Flow Area		sq ft	0.840	0.240	6.240	2.760	1.664	1.664	2.160
Wetted Perimeter		ft	8.82	2.82	12.95	10.47	9.57	9.57	11.65
r	hydraulic rad.	ft	0.095	0.085	0.482	0.264	0.174	0.174	0.185
s	slope	ft/ft	0.921	0.530	0.535	0.441	0.856	0.806	1.000
v	velocity	ft/sec	6.62	4.65	14.88	9.03	9.54	9.26	10.76
Q	Discharge	cfs	5.56	1.12	92.87	24.93	15.88	15.41	23.24
L	flow length	ft	977.00	774.00	2701.00	1077.00	993.00	1023.00	1685.00
Tt	travel time	hours	0.04	0.05	0.05	0.03	0.03	0.03	0.04
Open Chnl--Trapezoidal									
Mannings n		n	0.04		0.04	0.04	0.04	0.04	
Begin Elev		ft	800		955	1575	1050	1300	
End Elev		ft	130		120	110	115	150	
Flow Depth		ft	0.25		1.4	0.55	0.4	0.38	
Bottom Width		ft	4		4	4	4	4	
Side Slopes		H:V	3.0		3.0	3.0	3.0	3.0	
Flow Area		sq ft	1.188		11.480	3.108	2.080	1.953	
Wetted Perimeter		ft	5.58		12.85	7.48	6.53	6.40	
r	hydraulic rad.	ft	0.213		0.893	0.416	0.319	0.305	
s	slope	ft/ft	0.521		0.276	0.504	0.546	0.669	
v	velocity	ft/sec	9.58		18.16	14.72	12.83	13.80	
Q	Discharge	cfs	11.37		208.45	45.73	26.69	26.95	
L	flow length	ft	1286.00		3022.00	2909.00	1713.00	1720.00	
Tt	travel time	hours	0.04		0.05	0.05	0.04	0.03	
Total TOC			0.21	0.10	0.20	0.19	0.19	0.22	0.14

APPENDIX B

Calculations for Land Application

(Page B1 to B8)

Niblack Permeability Tests

1/14

Test Hole #1 – depth of hole 18 inches (top 6 inches organic layer, bottom 12" topsoil). Diameter of hole 6 to 8 inches. Put rock chips in bottom 2 inches of hole. Placed ruler to hole bottom. Started hole saturation with water at 12 inches above bottom.

Time	Water Level	Notes
1:10 PM	12"	
1:20 PM	11.5"	
1:30 PM	11.5"	Saturation stabilized – bail down water to 8" and start test.
1:40 PM	8.0"	
2:10 PM	7.9 to 8.0"	
2:40 PM	7.7 to 7.8"	
3:13 PM	7.5"	

Average percolation rate is 0.5" per 90 min

8" / Day

Test Hole #2 – depth of hole 15 inches (top 3 inches organic layer, bottom 12" topsoil). Diameter of hole 6 to 8 inches. Put rock chips in bottom 2 inches of hole. Placed ruler to hole bottom. Started hole saturation with water at 12 inches above bottom.

Time	Water Level	Notes
1:17 PM	12"	
1:27 PM	12"	
1:40 PM	11.8"	Saturation stabilized – bail down water to 8" and start test.
1:45 PM	8.0"	
2:15 PM	7.9 to 8.0"	
2:43 PM	7.8 to 7.9"	
3:15 PM	7.7 to 7.8"	

Average percolation rate is 0.2" per 90 min

3.2" / Day

Test Hole #3 – depth of hole 18 inches (top 6 inches organic layer, bottom 12" topsoil). Diameter of hole 6 to 8 inches. Put rock chips in bottom 2 inches of hole. Placed ruler to hole bottom. Started hole saturation with water at 12 inches above bottom.

Time	Water Level	Notes
1:40 PM	12"	
1:50 PM	12"	Saturation stabilized – bail down water to 8" and start test.
1:50 PM	8.0"	
2:18 PM	8.2"	Water rose due to previous saturation at higher level.
2:50 PM	8.0"	
3:40 PM	7.5"	

Average percolation rate is 0.5" per 110 min

6.5" / Day

Test Hole #43 – depth of hole 18 inches (top 6 inches organic layer, bottom 12" topsoil). Diameter of hole 6 to 8 inches. Put rock chips in bottom 2 inches of hole. Placed ruler to hole bottom. Started hole saturation with water at 12 inches above bottom.

Time	Water Level	Notes
2:05 PM	12"	
2:30 PM	9.5"	Assume saturation stabilized – bail down water to 8" and start test.
2:30 PM	8.0"	
3:00 PM	7.4 to 7.5"	
3:30 PM	7.0"	
5:05 PM	5.75"	

Average percolation rate is 0.5" per 30 min

24" / Day



SEPTIC SYSTEMS IN THE YUKON

GUIDELINES FOR SOILS INVESTIGATION AND PERCOLATION TESTS

SOILS INVESTIGATION

A test pit is often the best method to use to determine soil conditions because the soil layers can be visually inspected and recorded easily.

Test pits must be within 3 metres (10 ft.) of the anticipated disposal site, and must extend at least 1.2 metres (4 ft.) below the anticipated bottom of the soil absorption system (see Figure 1).

For large systems (commercial buildings, dwellings with 5+ bedrooms) more than one test pit and percolation test hole may be required.

Once the test pit has been dug, information on the types of soil (see Table 1) are to be recorded on your application form available from the Environmental Health Office.

PERCOLATION TEST

The percolation test provides the data necessary to properly design your soil absorption system. The percolation rate is expressed as the time in minutes that it takes for water to drop 25 mm (1 in.) in the test hole.

Following is an approved procedure for carrying out the percolation test (see Figure 1):

- (1) To determine the depth for your test hole, it is best to excavate a hole with a backhoe to a depth of 3 m (10 ft.) or more, obtain soils information and select the soil layer that you think is suitable for the absorption of the sewage effluent. Then excavate a bench or step on the sidewall of the test pit. When the test is made from a step or bench of a test pit, the percolation test hole therein should not be closer than 0.5 m (1.6 ft.) to the sidewall of the pit.
- (2) The test hole is to be augured or dug with a diameter of 150 mm (6 in.) maintaining a vertical attitude into the soil layer intended to accept the sewage effluent (liquid from the septic tank). The bottom of the percolation test hole must be at least 1.2 m (4 ft.) above the groundwater level and bedrock/impervious soil layer.
- (3) The auger is likely to smear the soil along the sidewalls of the test hole. Therefore, it is necessary to scratch or scarify the bottom 0.5 m (1.6 ft.) sidewall as well as the bottom of the hole. This can easily be carried out with a pointed instrument/nails driven into a board.

- (4) Remove all loose soil material from the bottom of the test hole, then add 50 mm (2 in.) of 6 to 20 mm (1/4 to 3/4 in.) diameter drainrock to protect the bottom from scouring when water is added. The gravel can be contained in a nylon mesh bag to be removed after the test is performed for use in additional percolation tests.
- (5) Carefully fill the test hole with clean water to at least 300 mm (12 in.) in depth, and continue to do so until the soil is saturated. Saturation means that the void spaces between the soil particles are full of water. Keep soaking the hole until the rate at which the water seeping away becomes constant.

In the event that the soil layer consists mainly of:

- (a) heavy silts or clays, then water must be kept in the hole to allow for saturation and swelling. Keep water in the hole for at least 4 hours, preferably overnight. Refill, if necessary, or supply a surplus reservoir of water, maintaining the 300 mm (12 in.) depth with an automatic siphon. Use a hose or similar device to add water to the hole and to prevent washing down the sides of the hole. Measure the percolation rate after at least 16 hours, but no more than 30 hours after water was first added to the hole. This ensures that the soil has an ample opportunity to swell and to approach the natural condition during the wettest season.
- (b) sand and gravel, and you are unable retain water in the hole after attempting to saturate the soil, then you may assume that your rate of percolation is less than 5 min./25 mm (1 in.). Should this be the case, then 2 ft. of filtered sand may be required. Information on the sand filter may be obtained from the Environmental Health Office.

(6) Measuring the Percolation Rate:

- (a) After the soaking period, bail out or fill up the water so that 150 mm (6 in.) of water remains above the gravel and is 200 mm (8 in.) from the hole bottom. Measure the drop in water level to the nearest 3 mm (1/8 in.) every 30 minutes. After each measurement, refill the water in the hole so that the liquid depth is once again 150 mm (6 in.) above the gravel.
- (b) In sandy soils, or in soils where the water seeps away in less than 30 minutes, after the soaking period, allow 10 minutes between measurements. If the soils are very sandy, use a stop watch, and measure the time taken to drop 25 mm (1 in.). Refill the test hole after each measurement to bring the water level to 150 mm (6 in.) above the gravel.

+
2 buckets
with gravel
or more
with water

Continue taking readings until 3 consecutive percolation rates vary by no more than 10 %.

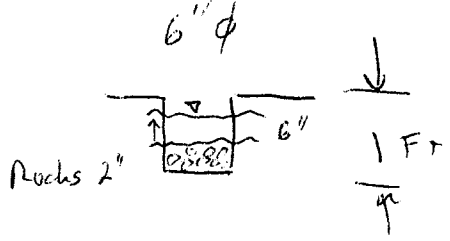

- ① Fill hole with water and keep filled until rate at which water falls constant
- ② Keep hole filled 6" above gravel
2
30 min measure drop fall to 6"
30 min
30 min

(7) Calculating the Percolation Rate:

When using the method of measurement as described in 8(a) divide the time interval by the drop in water level and multiply by 25 to determine the percolation rate in minutes per 25 mm (1 in.).

Example:

If water falls 19 mm in 30 minutes,
then water falls 1 mm in $(30 \text{ min.} \div 19 \text{ mm}) = 1.6 \text{ min./mm}$,
then water falls 25 mm in $(25 \text{ mm} \times 1.6 \text{ min./mm}) = 40 \text{ min.}$

or

If water falls 3/4 or 0.75 inch in 30 minutes,
then water falls 1 inch in $(30 \text{ min.} \div 0.75 \text{ in.}) = 40 \text{ min.}$

The percolation rate is 40 min per 25 mm (1 in.)

Calculate the percolation rate for each reading. When 3 consecutive readings vary by no more than 10 %, use the average of these 3 readings to determine the percolation rate for that test hole. Percolation rates in each test hole for a proposed soil absorption system should be averaged in order to determine the design percolation rate.

Once the percolation tests have been completed, record this information on your application form.

After the average percolation rate has been determined, the minimum soil absorption surface area required for your sewage disposal system can be obtained by using Table 2. This area is based on the number of bedrooms in a standard household, assuming a water usage of 570 litres per bedroom (125 gallons per bedroom).

For a 1 bedroom dwelling with a 10 min./ 25 mm percolation rate, the minimum area required for an absorption bed system would be 23 m₂ or 248 ft₂.

For a 3 bedroom dwelling with a 10 min./ 25 mm percolation rate, the minimum area required for an absorption bed system would be 23 m₂ (248 ft₂) / bedroom x 3 bedrooms for a total area of 69 m₂ or 744 ft₂.

Further information on the design and sizing of your sewage system is available from:

Environmental Health Services
#2 Hospital Road
Whitehorse, Yukon
Y1A 3H8

Phone: (403) 667-8391
Fax: (403) 667-8322
E-mail: Environmental.Health@gov.yk.ca

PAG Hydrograph--6 in Rainfall, CN = 90		
TOC = 0.1 hrs		
Time (hrs)	Q (cfs)	Volume (cu ft)
9	0.049973	53.97097
9.3	0.066631	71.96129
9.6	0.093283	100.7458
9.9	0.304836	109.741
10	0.561365	202.0913
10.1	0.839548	302.2374
10.2	0.543041	195.4948
10.3	0.258194	92.95
10.4	0.203224	73.16064
10.5	0.178237	64.16549
10.6	0.154917	55.77
10.7	0.134927	48.57387
10.8	0.121601	87.5529
11	0.109941	79.15742
11.2	0.099946	71.96129
11.4	0.093283	67.16387
11.6	0.089952	64.76516
11.8	0.08662	62.36645
12	0.081623	88.15258
12.3	0.076625	82.75549
12.6	0.073294	105.5432
13	0.066631	119.9355
13.5	0.059968	107.9419
14	0.053305	95.94839
14.5	0.049973	89.95162
15	0.048307	86.95323
15.5	0.046642	83.95484
16	0.044976	161.9129
17	0.04331	155.9161
18	0.039978	287.8451
20	0.033315	479.7419
24	0.021655	311.8323
28	0	4062.215 (cum vol.)

PROJECT Niblack JOB No. VA 10200205.01
 CALCULATIONS FOR Dripper Spacing REF. DRGS. SHEET No. 1/2
 DESIGNED VRD DATE 12/7/06 CHECKED VRK DATE 12/7/06

Adit Discharge = 120 gpm
 PAG pile Runoff = 20 gpm

Therefore, required land application rate for dripper system = $140 \frac{\text{gal}}{\text{min}}$

$$\begin{aligned} \text{Required application rate} &= 140 \frac{\text{gal}}{\text{min}} \times \frac{1440 \text{ min}}{\text{day}} \times \frac{1 \text{ ac-ft}}{325,872 \text{ gal}} \\ &= 0.62 \text{ ac-ft/day} \end{aligned}$$

Assume 0.5 ft/day infiltration rate from perc tests

$$\text{no. acres} \times \frac{0.5 \text{ ft}}{\text{day}} = 0.62 \frac{\text{ac-ft}}{\text{day}}$$

$$\text{no. acres} = \frac{0.62}{0.5}$$

$$= 1.24 \text{ acres}$$

$$= 54,014 \text{ sq. ft}$$

PROJECT Niblack JOB No. _____
 CALCULATIONS FOR Dripper Spacing REF. DRGS. _____ SHEET No. 2/2
 DESIGNED JRD DATE 12/7/06 CHECKED JRK DATE 12/7/06

$$140 \frac{\text{gal}}{\text{min}} \times \frac{60 \text{ min}}{\text{hr}} = \frac{8400 \text{ gal}}{\text{hr}}$$

Use Woodpecker
 DNPC6 pressure
 compensating drippers
 with 6 gal
 hr capacity
 at 10-70 psi

$$\frac{\frac{8400 \text{ gal}}{\text{hr}}}{\frac{6 \text{ gal}}{\text{hr}}} = 1400 \text{ drippers per zone}$$

$$1 \text{ zone} = 54,014 \text{ sq ft}$$

$$\frac{\frac{54,014 \text{ sq.ft}}{\text{zone}}}{1400 \text{ drippers}} = \frac{38.58 \text{ sq.ft}}{\text{driller}}$$

$$\sqrt{38.58 \text{ sq.ft}} = 6.21 \text{ ft grid spacing for drippers}$$



The knowledgeable source for drip irrigation needs

8/14
800/522-3747
Hours 8:00 to 4:30 PST
Monday thru Friday

ALL SEARCH Jump to catalog page: [dropdown]

- Home Menu
- Store
- Calculators
- Checkout
- Commercial
- Everliner
- Help

Pressure Compensating Emitters - RETAIL

Catalog Page 15

Related Products:
 Basic Drip Emitters
 Low Flow Sprinklers

PC emitters deliver a precise amount of water regardless of changes in pressure due to long rows or changes in terrain. They can simplify the designing of a system and greatly reduce maintenance since they rarely get plugged. Inside the emitter is a flexible diaphragm that regulates the water flow and tends to flush particles from the system (self-flushing). The reason we offer four different PC emitters is the range of water pressure, price and what each one can do.

Woodpecker PC (Netafim)

The heavy duty PC emitter! These have been the product of choice for many years in the rugged vineyards of Northern California. The EPDM diaphragm is the largest available and the least likely to plug. 1/4" inlet and outlet. Can be used at the end of 1/4" tubing.

PRESSURE RANGE OF 10-70 PSI.

Woodpecker emitters can be split 4 ways. See [Greenhouse Watering](#) page for information on Arrow Drippers.

- DNPC12 - Wdpkr PC, 1/2 GPH (# 2) 1-9 \$0.40 Each
- DNPC1 - Wdpkr PC, 1 GPH (# 4) 10-99 \$0.375 Each
- DNPC2 - Wdpkr PC, 2 GPH (# 8) 100+ \$0.35 Each

DNPC12 [dropdown] [input] [Show Cost] Quantity: 1 [Add]

- DNPC6 * 1-9 \$0.42 Each
- Wdpkr PC, 6 GPH (# 24) 10-99 \$0.39 Each
- 100+ \$0.365 Each

DNPC6 [input] [Show Cost] Quantity: 1 [Add]

- DNPCAP 1-9 \$0.16 Each
- Emitter Cap for DNPC 10-99 \$0.135 Each
- 100+ \$0.126 Each

DNPCAP [input] [Show Cost] Quantity: 1 [Add]

Woodpecker Jr. PC (Netafim)

This is a versatile emitter that can be used in landscapes, greenhouses, orchards or

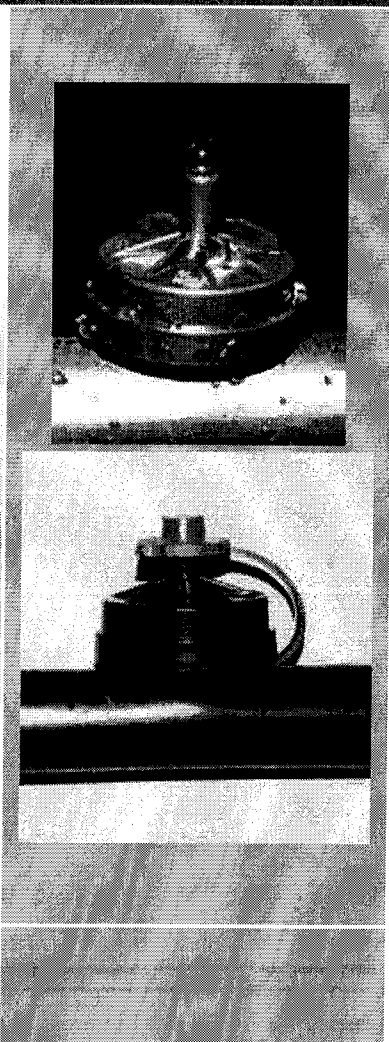

You have 0 line items in your Shopping Cart \$ 0.00

APPENDIX C

Land Application Reporting Form

Permit No.: _____
 Reporting Period: _____
 Page _____ of _____

A. HYDRAULIC APPLICATION RATE (average rate over entire land application site)

1. Total acreage of land application site(s) _____
2. Hydraulic application rate: _____

Column No.					
1	2	3	4	5	6
Year	Month	Million Gallons Wastewater	Acre-Inches Per Acre Wastewater	Million Gallons Supplemental Irrigation Water	Acre Inches Per Acre Irrigation Water
	January				
	February				
	March				
	April				
	May				
	June				
	July				
	August				
	September				
	October				
	November				
	December				
Totals					
		Million Gallons	Acre-Inches Per Acre	Million Gallons	Acre- Inches Per Acre

- Column 1: Enter the appropriate year (e.g. 1995) that the monthly loading took place.
- Column 3: Enter total wastewater applied in million gallons.
- Column 4: Multiply each monthly entry in column 3 by 36.83 to get acre inches; then divide by total acres to get acre inches per acre.
- Column 5: Enter estimate of supplemental irrigation water applied in million gallons.
- Column 6: Multiply Column 5 by 36.83 and then divide by the total acreage to get acre-inches per acre of supplemental irrigation water.